

Portable mini-winches

# **PULLEY-MAN 300 kg**

---

Manual instruction \_\_\_\_\_

**ENG**



**CE**

**252-113-14**

In an endeavour to improve its products, HUCHEZ reserves the right to alter the equipment featured herein and supply it, in this case, different to the illustrations or specifications of these instructions.

**Reproduction prohibited**

## Contents

1 - Conditions of use.....	2
2 - Safety instructions .....	3
3 - Warranty .....	4
4 - Reception of the equipment.....	5
5 - Obligatory regulatory checks by the user .....	5
6 - Presentation of the machines.....	6
7 - Handling - Storage - Transport .....	8
8 - Assembly and start-up.....	9
9 - Servicing and maintenance .....	15
10 - Decommissioning - Dismantling - Scrapping .....	22
11 - Example of the Declaration of Conformity.....	22
12 - Operating faults .....	23
13 - Annexes.....	24
A. Optional equipment	
B. Spare parts	
C. Maintenance booklet	

## 1 - Conditions of use

All users are asked to read the start-up instructions carefully before using the winch for the first time. These instructions will help the user to become familiar with the winch and to use it to the best of its capabilities. The start-up instructions contain important information on how to use the winch in a safe and correct manner. Observing these instructions can help prevent risks, minimize repair costs, reduce down time and increase the reliability and useful life of the winch. The instruction manual must always be available at the winch operation location. In addition to the start-up instructions and the regulations relating to accident prevention, it is important to consider current rules in terms of industrial safety and professional standards in force in each country.

### **This machine is covered by European regulations and, more specifically, machinery directive 2006/42/CE.**

These winches are designed to move loads using a suitable steel rope. They have been designed to perform lifting and pulling operations within the defined load capacity limit.

- The capacity indicated on the winch corresponds to the maximum capacity of use (MCU); in no event should this capacity be exceeded..
- This winch is intended for continuous operation for a period of 25 minutes at most.
- **THIS WINCH CAN UNDER NO CIRCUMSTANCES BE USED TO LIFT PEOPLE.**
- Do not begin moving the load until you have attached it correctly and checked that all personnel are outside the danger zone.
- Before use, the operator must always check that the machine, rope, hook, markings and moorings are in good working order.
- The operator must check that the load is attached in such a way that the winch, the rope and the load place neither the operator nor any other person is in danger.
- The winches can be used at ambient temperatures ranging from -10°C to +55°C. Please consult the manufacturer in the event of extreme conditions of use.
- Important: In the event of an ambient temperature below 0°C, the brake must be tested to ensure that there are no operating faults resulting from the freezing conditions.
- The data concerning the heat-resistance of the steel rope and its fastenings must be available on request from the manufacturer and must be respected.
- HUCHEZ cannot accept any liability for the consequences resulting from the use or installation of equipment not provided for in the present instructions or for the consequences of removal,

modification or replacement of original parts or components with parts or components from other sources without the written agreement of HUCHEZ.

- The use of winches requires strict compliance with the accident prevention and safety measures in force in the country where they are used.

## **YOU MUST ALSO RESPECT THE REGULATIONS APPLICABLE IN YOUR COUNTRY.**

### **2 – Safety instructions**

Before using the equipment, check that there are no causes of overloading such as: adhesion to the ground, suction, jamming, etc. of the load.

As the operator of the winch, you are responsible for your own safety and the safety of your colleagues in the work zone of the machine.

The operator must respect all the following safety information, without exception, concerning the handling and operation of the winch as well as the references to other sections of this instruction manual. Failure to comply with these instructions increases the level of risk.

- Only the people designated by the company are authorised to operate the winch
- Before using the winch for the first time, familiarise yourself with its conditions of use. To this end, read the present instruction manual carefully and in its entirety and perform all the operations described herein one after the other.
- Inform your departmental manager or the safety officer of any malfunction so that the fault can be repaired immediately.
- Respect the directives of the industrial accident prevention organisations such as, in France, the Caisse Régionale d'Assurance Retraite et de la Santé au Travail (C.A.R.S.A.T.) and the Health and Safety Committee (HSC) of your company, if one exists.
- Scrupulously respect all information in the sections concerning the CONDITIONS OF USE (section §1) and the WORK ROPE (section §8.1).
- The operator(s) must have an unimpeded view of the load.
- Please ensure that the operator is qualified to operate the machine in the conditions provided for in this manual. This will ensure the safety of both people and the environment.
- Do not lift or transport loads when there are personnel inside the danger zone.
- Do not authorise the personnel to walk under a suspended load.
- Do not leave a load suspended or with the rope taut unsupervised.
- Do not overload the winch.
- Do not remain immediately below the suspended load or the PULLEY-MAN.
- Make sure there is no-one and nothing in front of or behind a moving load.
- Remain at least 60 cm from the load, when using with drill as power source
- Keep the working area tidy and maintain lighting of at least 300 Lux.
- Install the PULLEY-MAN at least 1–1.5 m from any wall or obstacle.
- Fix or attach the load or the PULLEY-MAN so it is stable. Take the necessary measures, as appropriate.
- Do not keep or place your hands under the load when lifting.
- Do not use the winch near dangerous gas (such as an acid or alkali) or in flammable environments.
- Do not use the winch near an unprotected flame, excessive heat or sparks.
- Do not use it in damp or wet places or on rainy days (except for manual use), as this could cause an electric shock. If the PULLEY-MAN is used outside or in damp places, take precautions that follow the IP54 instructions.
- If a hand drill is used as a power source, use only the voltage and frequency specified on the labels.

In addition to the above instructions, we must warn you against all incorrect use or handling listed below. **It is dangerous and prohibited to:**

- **pull at an angle.**
- **swing the load.**
- **use ropes of a different diameter and texture to those specified in this instruction manual.**
- **use damaged ropes or ropes with splices.**

- **grab or touch a moving rope.**
- **use hooks without a latch, which do not correspond to the loads indicated on the winch or which are in poor condition.**
- **insert objects into moving parts.**
- **work on loaded winches or when the rope is taut.**
- **use the winch rope as a towing chain.**
- **place hands or clothes, etc. in contact with moving parts, in particular the areas where the rope is wound in/out.**
- **repair, clean, supervise and check the winch when the power supply is not turned off.**
- **use parts not supplied or certified by the manufacturer.**

---

### **3 – Warranty**

Our PULLEY-MAN portable mini-winches are guaranteed for 1 year from the date of shipment (ex-works).

The seller undertakes to repair any operating fault resulting from a fault in the design, execution, components or materials themselves.

The warranty does not cover wear and tear or damage resulting from a lack of regular or periodic maintenance. It does not cover damage resulting from a lack of supervision, incorrect handling or an incorrect use of the machines, in particular overloading, pulling at an angle, under or overvoltage or incorrect connection.

The warranty also does not cover damage occurring to a load worth more than 10,000 euros.

The warranty does not apply to any disassembly, modification or replacement of mechanical or electrical parts undertaken without our agreement or by a non-approved operator. The warranty only applies to the manufacturer's original spare parts. During the warranty period, the seller must replace or repair any parts recognised as faulty after inspection by the qualified and approved department, all free of charge.

The warranty excludes all other services or compensation.

Repairs undertaken within the scope of the warranty are, in principle, performed in the seller's workshops or the workshop of a representative approved by the manufacturer. When work is carried out on the equipment outside of their workshops, the seller must cover the labour costs related to the disassembly or reassembly of these parts if these operations are performed exclusively by their personnel or a representative approved by the manufacturer. The parts replaced become the property of the seller and must be returned to them at their own expense.

In the case of components with a particular relative importance not manufactured by the seller themselves and which bear the brand of a specialist manufacturer, the warranty, which may vary according to the manufacturer, is the same as that agreed by this manufacturer.

---

### **4 – Reception of the equipment**

- Make a visual inspection of the packaging to ensure that it is in good condition.
- In the event of a problem, issue the usual reserves.
- Check that the winch corresponds to your order.

---

### **5 – Obligatory regulatory checks by the user**

The users are required to comply with the standards in force in their country.

With regard to France:

Order of 1<sup>st</sup> March 2004 relating to the verification of lifting machines and accessories:

The modifications to the regulation relating to the use and verification of lifting machines and accessories, which came into effect on 1st April 2005, impose new obligations on all users:

- The suitability inspection that involves checking that the lifting machine is suitable for the work that the user intends to carry out, as well as for the risks to which workers are exposed, and that the intended operations are compatible with the conditions of use for the machine defined by the manufacturer.
- The assembly and installation inspection that involves ensuring that the lifting machine is assembled and installed safely in accordance with the manufacturer's instruction manual,
- The general periodic visits that involve an inspection of the state of preservation and the operating tests.
- The commissioning or recommissioning inspections in the event of a change in the place of use, the configuration or the conditions of use on the same site; following the disassembly and subsequent reassembly of the lifting machine; after any major replacement, repair or transformation concerning the essential components of the lifting machine; or following any accident caused by the failure of an essential component of the lifting machine.
- The maintenance booklet (order of 2nd March 2004 applicable from 1st April 2005) which must be used to record the maintenance operations carried out in accordance with the recommendations of the manufacturer of the machine as well as any other inspection, maintenance operation, repair, replacement or modification carried out on the machine. For each operation, it is essential to record the date of the work, the names of the people and, where appropriate, the companies which carried out the work, the nature of the operation and, if it is a periodic operation, the frequency. If the operations involve the replacement of certain components of the machine, the references of these components are indicated. The English version of the maintenance booklet for our lifting winches can be downloaded from our website [www.huchez.com](http://www.huchez.com) under the heading "After sales services". A copy is however proposed in the annexes of this manual.

The inspections must be carried out in accordance with a protocol and are intended to ensure preventive maintenance aimed at detecting any damage or defect liable to cause a hazard.

## 6 – Introduction to the machines

PULLEY-MAN portable winches are lifting and pulling equipment manufactured in accordance with the standards and regulations in force.

They are used to lift and transport loads.

### 6.1 – Description

- The PULLEY-MAN basically consists of reduction gear, a frame and a pulley.
- Automatic load handling system (reduction gear with patented self-locking brake mechanism).
- Power supply: The PULLEY-MAN can be used with all cordless and conventional screwdriver/drills.
- Rope length:
  - unlimited when pulling
  - limited to 50 m when lifting (beyond 12 m, loss of 10% of lifting strength per 10 m length).
- Delivered as standard with 12 m of rope (Ø 4.76 mm galvanised steel rope).
- Possible options: cf. Appendices - §A – Optional equipment.

### 6.3 – Dimensions

#### Dimensions in mm

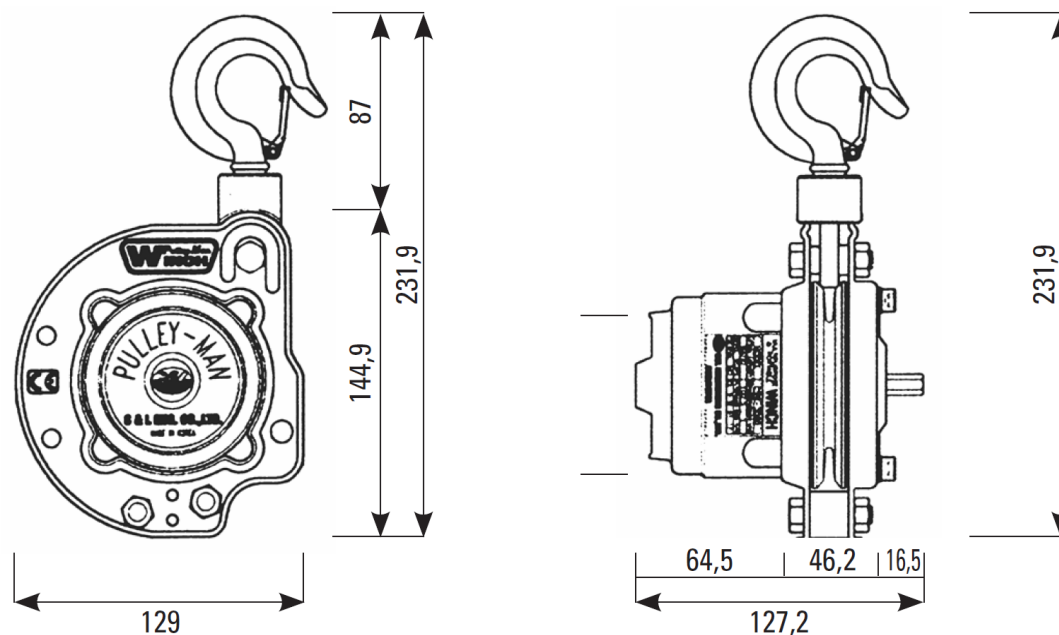

## 6.4 – Technical specifications

References	PULLEY-MAN
Load <b>lifting</b> capacity <b>on one fall</b> (kg)	300
Load <b>lifting</b> capacity <b>on two falls</b> (kg)	600
<b>Pulling/hauling capacity on one fall</b> for a load on wheels depending on gradient (6°/12°/16°/27°/35°) (kg)	1,500/975/825/585/450
<b>Pulling/hauling capacity on two falls</b> for a load on wheels depending on gradient (kg)	3,000/1,950/1,650/1,170/900
Rope length	- unlimited when pulling/hauling - limited to 50 m when lifting (beyond 12 m, loss of 10% of lifting strength per 10 m length).
Rope	Ø 4.76 mm (7 x 19) galvanised steel rope. 12 m with hook, sleeving and end stop.
Linear speed (empty/fully loaded) <b>on one fall</b> m/mn	10.3/3.73
Linear speed (empty/fully loaded) <b>on two falls</b> m/mn	5.1/1.85
Weight (with 12 m of rope and hook) kg	7.5

## 6.5 - Accessories (optional)

PULLEY-MAN portable mini-winches are delivered as standard with 12 m of rope and a hook. They can also be delivered in complete kit form (case, winch, drill – cordless drill 18 V 4 A, 1,700 revs/min. max., reversible, charger, sling and shackles), with a wall bracket or even a pulley block.

## 6.6 – Operation

The PULLEY-MAN can be used as a winch or a hoist:

- PULLEY-MAN can operate as a winch or hoist, moving the load horizontally or with an angle of inclination.
- PULLEY-MAN can be used in all positions, even 360°.
- The pulling capacity varies with the weight of the load and the inclination of the rope:

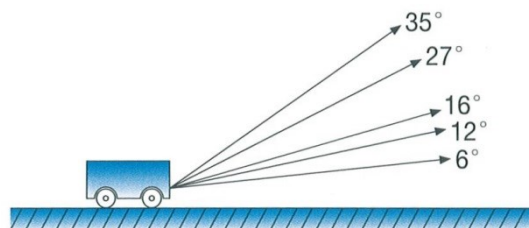

Maximum load capacity for haulage on wheels on a flat surface, depending on the gradient	Use on 1 fall		Use on 2 falls	
	6°	1,500 kg	3,000 kg	
	12°	975 kg	1,950 kg	
	16°	825 kg	1,650 kg	
	27°	585 kg	1,170 kg	
	35°	450 kg	900 kg	

### Important!

Leave 10% to 50% tolerance with respect to the maximum capacities.

The figures can change depending on the working conditions, the environment or the friction coefficient of the load.

- The methods for fixing the PULLEY-MAN are the same both for lifting and pulling a load: it is a good idea to choose the method best suited to the working conditions.

---

## **7 – Handling – Storage – Transport**

- The PULLEY-MAN portable mini-winch is easy to store and transport.
- Separate the power source (e.g. drill) from the main body before storage.
- Separate the rope from the main body and roll it up properly.
- If it is not going to be used for a long time, clean well and lubricate.
- When the main body is damaged, repair before storage. If spare parts are needed, use those supplied or recommended by the manufacturer.
- Keep the PULLEY-MAN protected from damp and dust. As with any machine including electrical equipment, these winches must be stored protected from weather conditions and at a temperature between 0°C and + 55°C.
- When transporting the equipment, secure the hook firmly to the main body. Protective gloves should be worn.



## 8 – Assembly, set-up and use

### Important!

Assembly and dismantling must be carried out by qualified personnel. The PULLEY-MAN basically consists of reduction gear, a frame and a pulley, and is assembled/dismantled in accordance with the following procedure.

### 8.1. Rope assembly

#### 8.1.1. Procedure

The rope must be separated from the main body while it is not assembled on the PULLEY-MAN.

The procedure below should be followed in order to fit the rope to the main body:

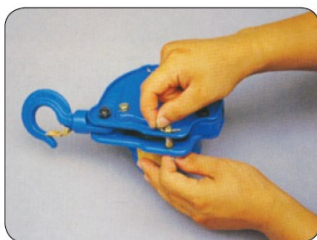

- 1) Remove the cotter pin and pull the input-side locking pin ring.

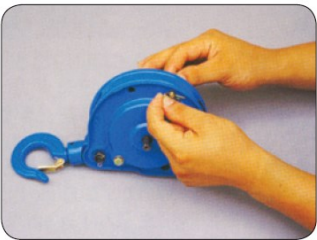

- 2) Remove the cotter pins and pull the locking pins of the pressure roller housing.

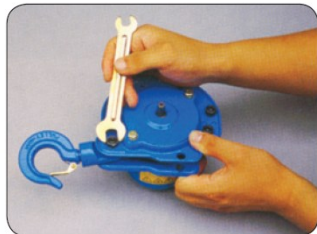

- 3) Use with one fall:  
Remove the hook from the main body.  
Remove the locknut and nut and take out the hex bolt.

Use with two falls:  
Remove the hook fixing.  
Remove the locknut and nut and take out the hex bolt.



- 4) Insert the rope in the pulley groove.  
Important! The direction of insertion is from the input-side locking pin towards the pressure roller housing.  
Pull out enough length of rope for use before fitting it in the pulley groove.

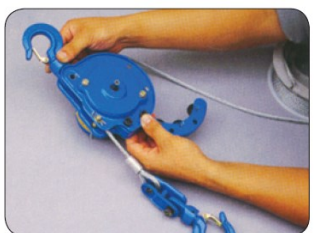

- 5) Put in the input-side locking pin and the housing-side flange pin.  
Insert the cotter pin.  
6) Use with one fall:  
Remove the hook from the main body.  
Tighten the hex bolt and the locknut and introduce the locking pin.

Use with two falls:  
Reassemble the hook fixing.  
Tighten the hex bolt and the locknut and insert the locking pin.

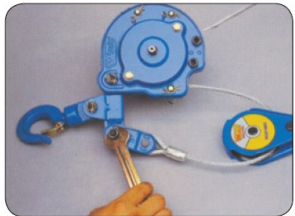
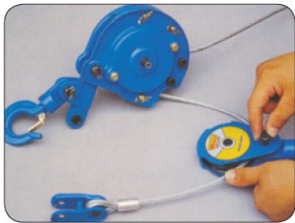
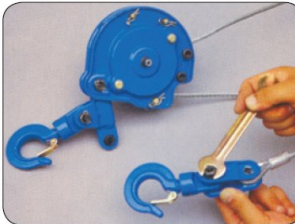
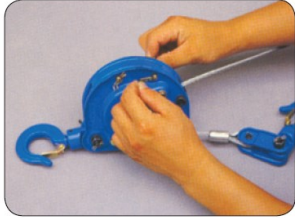

- 7) Compress the rope with the pressure roller housing.  
Lift the pressure roller housing to an angle of about 90° and pass the rope between the output roller and the pulley rim.  
Pull the rope in the direction of the sleeve end so it is at the bottom of the pulley groove.  
Close the pressure roller housing in the direction of the flange to compress the rope.  
**Important!** Check that the pressure rollers are compressing the rope.
- 8) Insert the pressure roller housing locking pin.  
When the locking pin holes on the flanges and the pressure roller housing are aligned, insert the locking pins from the reduction-gear side and insert the cotter pins.  
**End of the procedure if using one fall.**
- 9) Separate the hook from the hook support.  
Remove the locknut, the bolt and the hook support nut that connects the rope hook to the end of the rope.
- 10) Install the rope on the pulley and reassemble the hook.  
Insert the rope between the pulley and the pulley cover. Before reassembling the hook, check whether the rope is correctly placed in the centre of the pulley groove.  
Tighten the bolt and the nut and insert the locknut.  
Reassemble the hook and the hook support.
- 11) Reattach the hook support to the hook fixing.  
Assemble the hook support on the hook fixing.  
Tighten the nut and introduce the locknut.  
**End of the procedure if using two falls.**

Follow the procedure in reverse to take the rope out of the main body.

### 8.1.2. – Rope end

#### 8.1.2.a. Sleeving:



Use cold-pressed steel.

**IMPORTANT!**

- When using a rope longer than the one supplied by the manufacturer (12 m), use a rope recommended by the manufacturer, fix the end of the rope using one of the methods illustrated above and attach it to the hook support (the rope supplied by the manufacturer is sleeved).
- When fixing the end of the rope, the safety factor must be at least five times the load and a safety test must be carried out before use.
- Contact the manufacturer if a rope longer than 12 m is used.

## 8.1.2.b. Fixing the stop sleeve end:

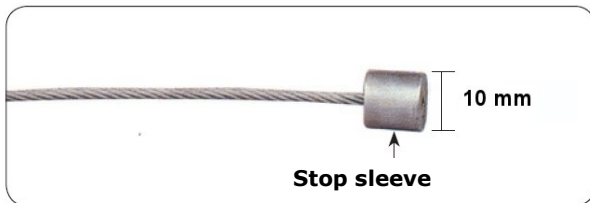

Fix the other end of the rope to the steel cube with sleeving. The thickness of the steel must be greater than 10 mm after sleeving. Remove excess rope from the stop sleeve end by grinding.

**8.2. – Power supply**

**Important!** If the PULLEY-MAN is used as a hoist, it should be earthed to protect it from lightning.

**8.2.1. Hand drill:**

**Important!** Product not supplied by the manufacturer, so check the following:

- Specifications: 110/220 V single phase, min. 550 W, 3,000 rev./min., reversible
- Precautions:
  - Install anti-leakage insulation to the main power supply and earth.
  - Use the main power supply voltage specified on the label.
  - If used as a power supply, make sure the chuck is properly fixed to the hexagonal end of the input shaft.
  - Do not touch the rotating chuck.

**8.2.2. Cordless drill:**

**Important!** For products not supplied by the manufacturer (others supplied optionally with the model), check the following:

- Specifications: 3/8" (10 mm), 18 V DC max., max. torque 230 inches/pound or more, reversible.
- Precautions:
  - Use fully charged.
  - If used as a power supply, make sure the chuck is properly fixed to the hexagonal end of the input shaft.
  - Do not touch the rotating chuck.

### 8.3. Installing the PULLEY-MAN

Several fixing methods are possible:

#### Fixed PULLEY-MAN



Fix the main body to an I-beam, round beam or another stable, raised structure and attach the load to be vertically moved to the rope.

**IMPORTANT!** Conditions to be followed for fixing the PULLEY-MAN:

- . The raised structure must be solid enough to bear the load weights.
- . When fixing the PULLEY-MAN to shackles at the end of an extension arm, the length of the extension arm must not be too long.

Conditions affecting the raised structures (Reach: 2 metres):

PULLEY-MAN	I-beam	H-beam	Round beam
300 kg	100 x 75 x 5 x 8 mm	100 x 100 x 6 x 8 mm	Ø 80 mm
600 kg	125 x 75 x 9,5 x 9 mm	150 x 75 x 5 x 7 mm	Ø 80 mm

#### Fixed rope hook



Fix the rope hook to an I-beam, round beam or another stable, raised structure and attach the load to the hook on the main body to move the load vertically.

**IMPORTANT!** Conditions to be followed for fixing the PULLEY-MAN:

- . The raised structure must be solid enough to bear the load weights.
- . When fixing the rope hook to shackles at the end of an extension arm, the length of the extension arm must not be too long.

Conditions affecting the raised structures (Reach: 2 metres):

PULLEY-MAN	I-beam	H-beam	Round beam
300 kg	100 x 75 x 5 x 8 mm	100 x 100 x 6 x 8 mm	Ø 80 mm
600 kg	125 x 75 x 9,5 x 9 mm	150 x 75 x 5 x 7 mm	Ø 80 mm

## PULLEY-MAN fixed to the ground

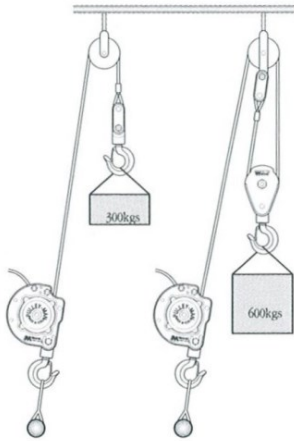

Fix the main body to a stable anchorage on the ground.

Pass the rope through a pulley fixed to an I-beam, round beam or another stable, raised structure and attach the load with the rope for vertical movement.

### 8.4. Installing the load

When the installation of the PULLEY-MAN is complete, you need to make the following checks before attaching the load:

- Eliminate all potentially hazardous factors and obstacles from around the working area.
- Check the main body, the hook and whether the rope is tangled or twisted.
- Check whether the rope moves up and down correctly with no load.

You can then attach the load to the rope or the shackles in complete safety, in accordance with the instructions in this manual.

**Important!** Do not overload the winch.

### 8.5. Using the PULLEY-MAN

When the installation of the PULLEY-MAN is complete, begin use in accordance with the instructions in this manual.

**Important!** Do not overload the winch.

#### 8.5.1. Before using the PULLEY-MAN

It is a good idea to:

- check that the PULLEY-MAN's connections are properly tightened.
- check the rope for wear or deterioration.
- check the rope is inserted in the right direction.
- check that the rope is properly installed in the pulley groove and that the pressure rollers are compressing the rope properly.
- check that the nuts are properly locked and that the locknuts are in place.
- check that the rope hook safety latch is working properly.
- check that the hazard labels and signs are properly fixed.
- your head must be protected with a hard hat that meets safety regulations.
- wear safety shoes to protect your feet.
- use safety gloves.
- check that work clothing does not include loose items like ties or floppy sleeves.

### 8.5.2. While using the PULLEY-MAN



### Attention !

**Never detach the drill (or screwdriver) from the PULLEY-MAN during use: risk of a sudden fall or movement of the load.**

It is a good idea to take the following precautions:

- Continuous operating time: 25 minutes.
- For lifting operations:
  - To prevent the top of the load knocking into the bottom of the main body of the PULLEY-MAN, maintain at least 30 cm between the bottom of the main body and the rope hook.
  - Do not fix to a moving load.
  - Do not change the direction of the power supply abruptly.
  - Do not remain immediately below a suspended load or the PULLEY-MAN and keep out of the way of the vertical line of a suspended load.
  - Make sure the loose rope does not get tangled up with the power cable.
  - Keep the loose rope away from the lifted load.
  - Do not walk on the loose rope.
  - Follow all other safety laws and regulations.
- For pulling/hauling operations:
  - Check the rope is aligned in the pulley groove.
  - Do not leave any obstacle between the pulley and the load that puts the rope at an angle. (This can wear or break the rope).
  - Check that no-one and nothing is in front of or behind the moving load.
  - Do not change the direction of the power supply abruptly.
  - Do not walk on the loose rope during use.
  - Make sure the loose rope does not get tangled with the power cable.
  - Keep the loose rope that has passed through the pulley away from the load to be moved.
  - When the surface on which the load is being pulled is irregular or has hollows or holes, use a plate to keep the route level.  
Example: Where there is a gap, stairs or rising ground or when it is a load on a mechanical tractor, etc.
  - When pulling a load on an inclined surface and when the load is unbalanced, take safety measures to prevent the load slipping.
  - Do not halt operation when pulling a load on an inclined surface without taking control or safety measures.
  - Do not fix to a moving load.
  - Follow all other applicable safety laws and regulations.

### 8.5.3. After using the PULLEY-MAN

You must make sure you:

- Turn off the power supply.
- Do not halt operation with a suspended load.
- After use outside, tidy up everything in the area and put the PULLEY-MAN away in accordance with the instructions in this manual.

## 9 – Servicing and maintenance

The PULLEY-MAN portable mini-winch has been designed to keep maintenance strictly to a minimum.

Although PULLEY-MAN is easy to install and use, it must be used and maintained properly so that it operates and remains at maximum capacity.

Only people designated by the company are authorised to use, check and maintain the winch.

Warning labels are fixed on the PULLEY-MAN for complete safe use and maintenance. Make sure they stay there so you can refer to them.

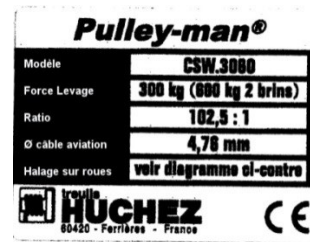
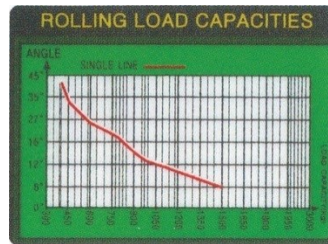

**Warning!**

Incorrect maintenance can lead to the risk of death or serious injury.



**Attention !**



Warning of electrical hazard:

Physical contact during operation can lead to immediate injury. Parts bearing this symbol must be handled only by qualified technicians. The power supply must be turned off when these parts are being handled.



Suspended load warning:

Operation under a suspended load can lead to serious accidents. Do not walk under a suspended load.



Warning when handling during installation:

This symbol in the manual indicates a warning. Ignoring it can lead to damage to the PULLEY-MAN or the load.

**IMPORTANT!** Respect the following points before and during maintenance or repair:

- 1) Turn off the power supply.
- 2) Place a label on the wall socket specifying "Out of service".
- 3) Never start maintenance work while a load is suspended.
- 4) Maintenance must be carried out by maintenance personnel.
- 5) When maintenance work is carried out with a PULLEY-MAN installed in fixed PULLEY-MAN mode, use a ladder or mobile platform for safety.

## 9.1 – Dismantling



Check whether there are signs of abrasion or deterioration of sprocket wheels, rings, bearings, shafts or pulley grooves.

To do this, follow the dismantling procedure given below:



1. Unscrew the two M6 screws and remove the input-side flange cover.



2. Remove the input-side cotter pins and those of the pressure roller housing.



3. Remove the hook and the locknut and unscrew the hex bolt.



4. Remove the hex bolt (M8) and the nut and then the pressure roller housing from between the flanges.



5. Remove the M8 bolt, making a space between the flanges.



6. Remove the retaining ring from the input-side flange.



7. Remove the input-side flange from the output shaft.



8. Remove the flange spacer.





9. Remove the pulley retaining ring on the output shaft.



10. Remove the pulley from the output shaft.



11. Remove the output-side flange retaining ring on the output shaft.



12. Unscrew the four (Allen) bolts fixing the reduction gear to the flange.



13. Remove the output-side flange from the output shaft.



14. Remove the output shaft from the gear housing.



15. Remove the input shaft assembly (planetary and solar gear) from the gear housing.

**Important!** Do not dismantle the input shaft assembly. Once dismantled, it cannot be reassembled. When the sprocket wheels are used or damaged for external reasons, they must be changed.

Once the PULLEY-MAN has been dismantled, proceed with the following checks:

- Signs of wear and deterioration:
  - Wear to sprocket wheels, rings, shafts and pulley grooves.
  - Deformation of the flange.
  - Wear and rotation of the hook and swivel mechanism.

- Lubrication
  - The PULLEY-MAN reduction gear is ready greased.  
Lubrication used: MoS<sup>2</sup>.
  - Applying the lubrication:
    - Apply grease to the sprocket wheels, rings and shafts.
    - Apply grease or oil to the hook swivel connection.
    - Apply grease to the pressure roller housing tensioners.
    - Dismantle the pulley and apply grease to its shaft.
  - Depending on the frequency of use, re-grease at least once a year as part of the maintenance programme.

## 9.2 – Reassembly

For reassembly, follow the dismantling procedure in reverse order and respect the following points:

- Do not apply excessive force to the sprocket wheel or shaft.  
In general, do not use excessive force or blows that could affect the life of the PULLEY-MAN and damage its parts and components.
- Make sure the rings do not deteriorate.
- Before fixing the sprocket wheel to the flange, first apply a fixing product to the four (Allen) bolts.

Once the PULLEY-MAN is reassembled, proceed as follows:

- Use the PULLEY-MAN without a load to see that it is properly assembled.
- Check that it is not making excessive noise.
- When no problems are detected, insert the rope.

## 9.3 Replacing parts and components

**Important!** Through daily and periodic checks, replace parts or components whose useful life has been reached or exceeded with new parts, in accordance with maintenance instructions.

### 9.3.1. Rope

Conditions and limits of rope use:



#### **Attention !**

- Less than 10% of the elementary strands are broken following twisting (1 step).
- The diameter of the rope must be reduced by less than 7%.
- There must be no bends (folded or twisted rope) or corrosion.
- When the rope is replaced, fix the end with a stop sleeve.
- The stop sleeve (fixed to one end of the rope to prevent the rope and load slipping off the pulley due to an excessive load) must be complete, without damage, and there must be no risk of the rope escaping or becoming separated from it.

**9.3.2. Hook**

The hook must have a latch to prevent the rope slipping out of it. The areas most subject to wear are the opening and the centre of the hook bearing the weight.

Hook limit values:

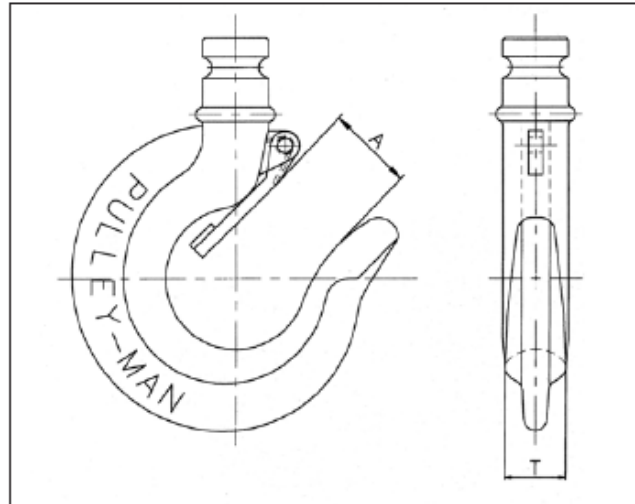

Item	Normal value	Limit value
Opening A (mm)	18.3	20.5
Hook centre T (mm)	13.15	11.8

**9.3.3. Pulley**

Wear in the pulley groove is caused by the rope, so the rope must also be checked.

Methods for recognising the limit values for the pulley groove with the naked eye:

- After production and heat treatment, the surface of the pulley groove is coated with black zinc.
- When holding the load, the black zinc coating becomes worn away to the point when the rope no longer moves at the bottom of the groove.
- When the equipment is used continuously, the score line moves to the bottom of the groove.

There are two reasons for this:

- the rope diameter is reduced: the rope is worn and must be replaced,
- the pulley groove is worn: if a new rope touches the bottom of the groove, it is time to replace the pulley.

<b>Worn rope</b> touching the bottom of the pulley groove.	<b>New rope</b> touching the bottom of the pulley groove.
1. Replace the rope 2. Mark the groove with an indelible marker.	1. Replace the pulley

### 9.3.4. Sprocket wheels

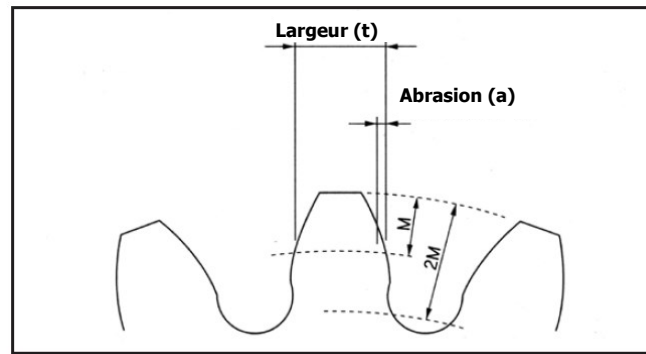

When the wear value reaches  $0.15 t$ , it is time to replace the sprocket wheel.

## 9.4 – Daily and periodic maintenance

It is essential to check the condition of the PULLEY-MAN with regular maintenance to maintain its useful life and ensure user safety.

Always keep the maintenance programme within reach.

A PULLEY-MAN user or maintenance personnel must have a thorough knowledge of the daily and periodic check points and safety rules in this manual.

Proper maintenance training must also be ensured.

When problems arise, take measures in accordance with the repair instructions in this manual (cf. § 12 – Operating faults). Consult the distributor or manufacturer for any other problems.

### 9.4.1. Daily checks

For safety reasons, carry out the following checks before beginning:

- Check that connections have not worked loose.
- Check that the rope is not damaged or worn.
- Check that the rope is inserted in the right direction.
- Check that the rope is properly inserted: towards the pulley and properly compressed by the pressure rollers.
- Check that the nuts are properly locked and the locknuts properly fixed.
- Check that the hook has a safety latch and that it is working properly.
- Check that the hazard labels are properly in place.

### 9.4.2. Periodic checks

Personnel in charge of the care and maintenance of the PULLEY-MAN must record any damage, wear, deformation, malfunctions, etc. in the maintenance log.





### PULLEY-MAN maintenance table

Maintenance			Points to be checked	Method	Standards
Daily	Periodically				
	Monthly	Annually			
<b>Rope</b>					
X	X	X	Rope breakage	Daily => with the naked eye Periodically => measured	Less than 10% of the elementary strands are broken after twisting.
X	X	X	Wear	Measurement	Less than 7% diameter reduction.
X			Deformation & corrosion	with the naked eye	There must be no bends or corrosion.
X			Stop sleeve	With the naked eye	It must be solidly fixed to the end of the rope.
<b>Hook</b>					
X	X	X	Opening	Daily => with the naked eye Periodically => measured	It must not be stretched
X			Deformation	with the naked eye	No warping or twisting
X	X		Latch	with the naked eye	No wear or deformation
X	X		Deformation & corrosion	with the naked eye	No excessive wear or corrosion
X	X		Other faults	with the naked eye	No bends or other faults
<b>Main body</b>					
X		X	Frame	Daily => with the naked eye Periodically => measured	No deformation or corrosion
X		X	Gear housing	with the naked eye	No deformation or corrosion
		X	Sprocket wheel	with the naked eye	No wear or corrosion
		X	Rings	with the naked eye	No excessive wear or corrosion
		X	Pressure roller housing	with the naked eye	No abrasion, deformation or deterioration
X		X	Pulley	with the naked eye	No excessive wear or corrosion The rope must not touch the bottom of the groove (mark the groove with an indelible marker).
X			Accessories	with the naked eye	No wear, damage or corrosion
<b>Input power supply</b>					
	X		Hand drill	Measurement	It must work normally at 90% of the required voltage
	X		Cordless drill	Measurement	Check the condition of the rechargeable battery
X			Earth connection	Measurement	It must be fully earthed

## 10 – Decommissioning – Dismantling – Scrapping

Once the equipment has reached an age at which it may pose hazards, the user is obliged to dispose of the equipment, i.e. taking it out of operation and dismantling it if required.

## 11 – Declaration of conformity

			
<b>DECLARATION OF CONFORMITY</b>			
<b>PARTLY COMPLETED MACHINERY</b>			
<small>F03.38 ENG Pulley-man.</small>			
<b>We hereby declare that the tripod (partly completed machinery) designed below complies in terms of its design and manufacture with the pertinent requirements of the Machinery Directive 2006/42/CE, except with the following :</b>			
<ul style="list-style-type: none"><li>▪ This winch can be used only after incorporation of a motorization through a drill with or wirelessly and must not be put in service before the set has been declared compliant with the pertinent provisions of this Directive, when applicable.</li></ul>			
<b>Device type:</b>	<b>Portable hoist</b>		
<b>Model:</b>	<b>Pulley-man</b>		
<b>Force:</b>	<b>300 kg</b>		
<b>Serial N°:</b>			
<b>Final function:</b>	<b>Equipment lifting</b>		
<b>Quality assurance:</b>	<b>ISO 9001 (certificate registration no : FQA 9911492)</b>		
<b>Equipment delivered:</b>	<input checked="" type="checkbox"/> without motorization		
	<input checked="" type="checkbox"/> with wire rope	<input checked="" type="checkbox"/> with hook	
<b>With user instructions</b>			
<p>The pertinent technical documentation is drawn up in accordance with Appendix VII-B. We undertake to send, following a duly justified request from the national authorities, the pertinent information concerning the portable hoist (partly completed machinery). This commitment will not, in any case, be prejudicial to our intellectual property rights over this device or any other device belonging to the same range. This declaration will be declared null and void in the event of an alteration or the addition of any elements not having previously received our approval. Moreover, this declaration will be declared null and void if the machine is not used in accordance with the instructions of its manual and if it does not undergo regular testing.</p>			
In Ferrières, on			
			<b>Antoine HUCHEZ,</b> <i>President</i>
<a href="http://www.huchez.fr">www.huchez.fr</a>	<small>HUCHEZ S.A.S Rue de l'Eglise 03420 Ferrières (France)</small>	<small>Tel. : +33 (0)3 44 51 11 33 Fax : +33 (0)3 44 51 13 13 contact@huchez.fr</small>	<small>S.A.S. with a capital of €500,000 RC Beaureux 526 020 482 APE 2922 Z VAT FR 80 526 020 482</small>
			

## 12 – Operating faults

If you have followed the instructions for assembly and use, any incidents that do occur should be minor.

The following instructions will help you resolve any faults quickly.

Fault	Points to be checked	Possible cause	Solution
The equipment does not start.	Does it have power?	The input switch is on Stop	<ul style="list-style-type: none"> <li>- Press the button firmly</li> <li>- Correct the power line properly</li> <li>- Check the power cable</li> </ul>
The equipment cannot hold the load	Is the rope hook properly inserted? Is the load weight within the acceptable capacity?	The input power supply causes excess noise and heat	<ul style="list-style-type: none"> <li>- Check the power supply voltage</li> <li>- Check the condition of the input power supply</li> <li>- Use a load corresponding to capacity</li> </ul>
Slipping	Slipping in stop mode?	Rope wear	- Change the rope
		Pulley groove wear	- Change the pulley
Electrical accident	Current leakage	There is electricity leakage along the main body and the rope	<ul style="list-style-type: none"> <li>- Earth it properly</li> <li>- Check the insulation</li> <li>- Eliminate damp and dry it</li> </ul>

If it is operating abnormally, take the measures indicated in this table.

For other anomalies, consult your distributor or the manufacturer.

---

## 13 – Appendices

A – Optional equipment

B – Spare parts

C – Maintenance booklet



## A – Optional equipment

---

### 1/ Possible options:



#### a. Single sling

Ref.:SANGLE30

#### b. Single shackle

Ref.:MANIELLELYRE600KG

#### c. Single drill with charger

Ref.:VISSEUSEBOSCH

#### d. Single case

Ref.:PULLEYMANMALLETTTE

#### e. Pulley block (to double loads)

Ref.:MOUFLE PULLEY MAN

#### f. Marine paint

Ref.:PULLEYMAN\_MARINE

#### g. Rope kits

- **20 m rope kit with loop**  
Ref.:PULLEYMANKITCABLE20
- **30 m rope kit with loop**  
Ref.:PULLEYMANKITCABLE30
- **40 m rope kit with loop**  
Ref.:PULLEYMANKITCABLE40
- **Other length kit with loop (by the metre)**  
Ref.:CBPULLEYMAN

#### h. Wall bracket

Ref.:PULLEYMAN\_SUPPORTMURAL



Dimensions of the wall bracket:

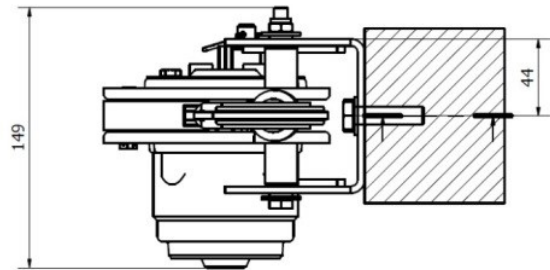
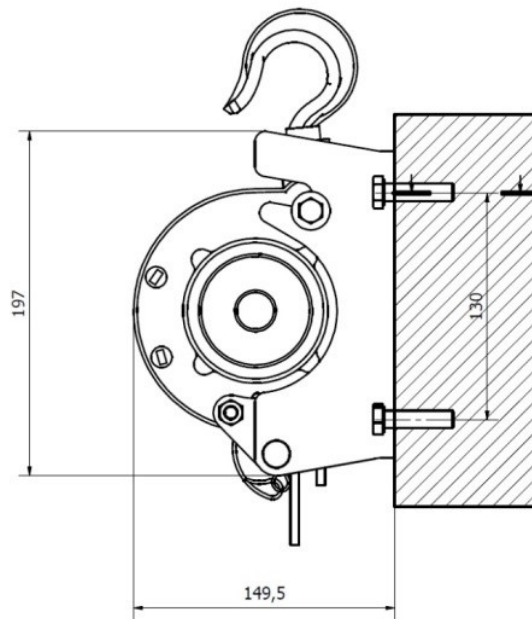

Dimensions in mm

## 2/ There is also a complete kit:



The **complete kit** includes: case, winch (standard model or model with marine paint), drill (cordless drill, 18 V, 4 A, 1,700 revs/min. max., reversible), charger, sling and shackles.

Ref.:  
PULLEYMANKITCOMPLET  
PULLEYMANKITCOMPLET\_MARINE

**B – Spare parts**

---

Description	Ref.
Hook	PULLEYMANCROCHET
Pressure roller	PULLEYMANPD_GALET
12 m rope kit with loop	KITPULLEYMAN
20 m rope kit with loop	PULLEYMANKITCABLE20
30 m rope kit with loop	PULLEYMANKITCABLE30
40 m rope kit with loop	PULLEYMANKITCABLE40
Other length kit with loop (by the metre)	CBPULLEYMAN

## **C – Maintenance booklet**

---



The English version of the maintenance booklet for our lifting winches can be downloaded from our website [www.huchez.com](http://www.huchez.com) under the heading "After sales services".

Date	Person in charge Company		Nature of the operation	References of replaced parts	Frequency if appropriate	Signature

Huchez© 2012