

Zinc Anode Belt XJ, XJC, XJS

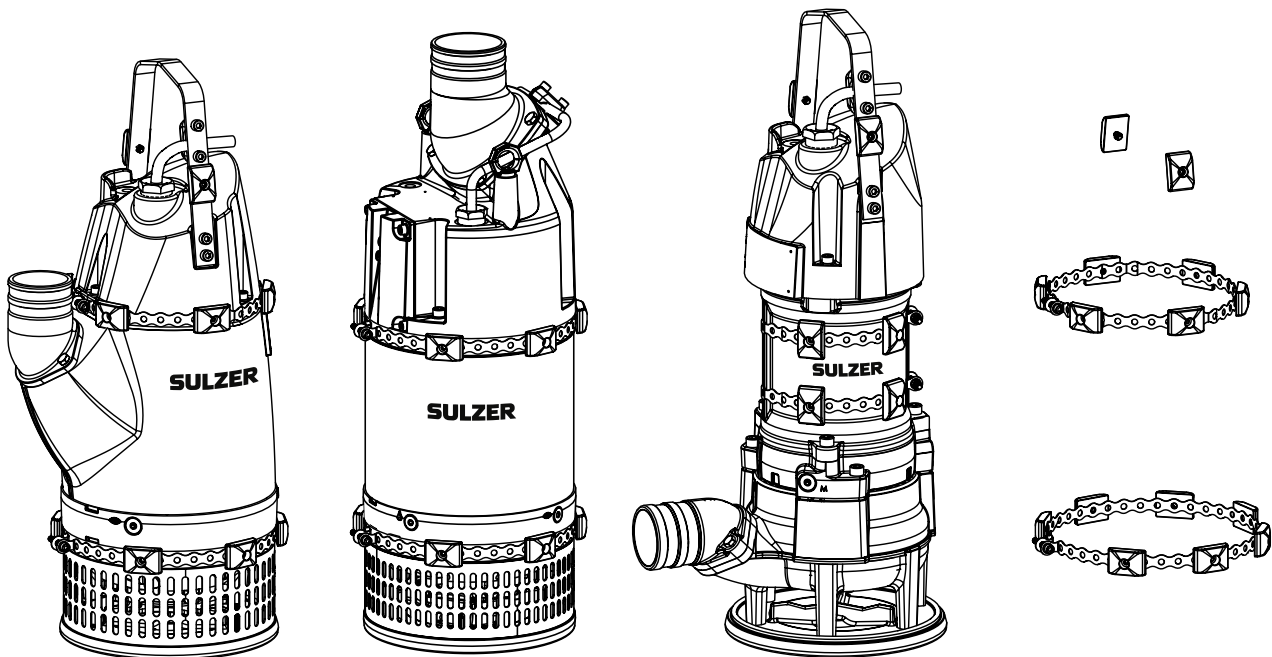

00833242AD 12.2015

- (SV) Monterings- och installationsinstruktion
- (EN) Assembly and installation instruction
- (DE) Montageanleitung
- (FR) Instructions de montage et d'installation
- (IT) Istruzioni di montaggio e installazione
- (ES) Instrucciones de instalación y montaje
- (PT) Instruções de montagem e instalação
- (ET) Koostamise ja paigalduse instruksioon
- (DA) Montage- og installationsvejledning
- (FI) Asennusohjeet
- (EL) Οδηγίες εγκατάστασης και συναρμολόγησης
- (NL) Montage- en installatie instructies
- (NO) Montering- og installasjonsinstruksjon

- (BG) Инструкция за монтаж
- (CS) Návod na montáž a instalaci
- (HR) Uputa za montažu i instalaciju
- (HU) Összeállítási és szerelési útmutató
- (LT) Surinkimo ir pastatymo instrukcija
- (LV) Montāžas un uzstādīšanas instrukcija
- (PL) Instrukcja instalacji i montażu
- (RO) Instrucțiuni de asamblare și instalare
- (SI) Navodila za montažo
- (SK) Návod na montáž a inštaláciu
- (TR) Montaj ve kurulum talimatları
- (RU) Руководство по монтажу
- (ZH) 装配及安装说明

Zinc anode belt kits

Zinc anode belt XJ 25 - XJ 40

Zinc anode belt XJ 50 - XJ 110

Zinc anode belt XJS 25 - XJS 40

Zinc anode belt XJS 50 - XJS 110

Pump models

XJ 25, XJ 40

XJ 50, XJ 80, XJ 110, XJC 50, XJC 80, XJC 110

XJS 25, XJS 40

XJS 50, XJS 80, XJS 110

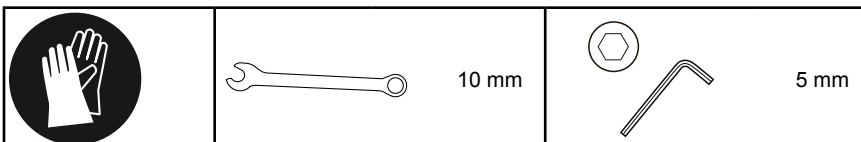

Zinc anode belt

XJ 25 - XJ 40 (P/N 00863179)

XJ 50 - XJ 110, XJC 50 - XJC 110 (P/N 00863178)

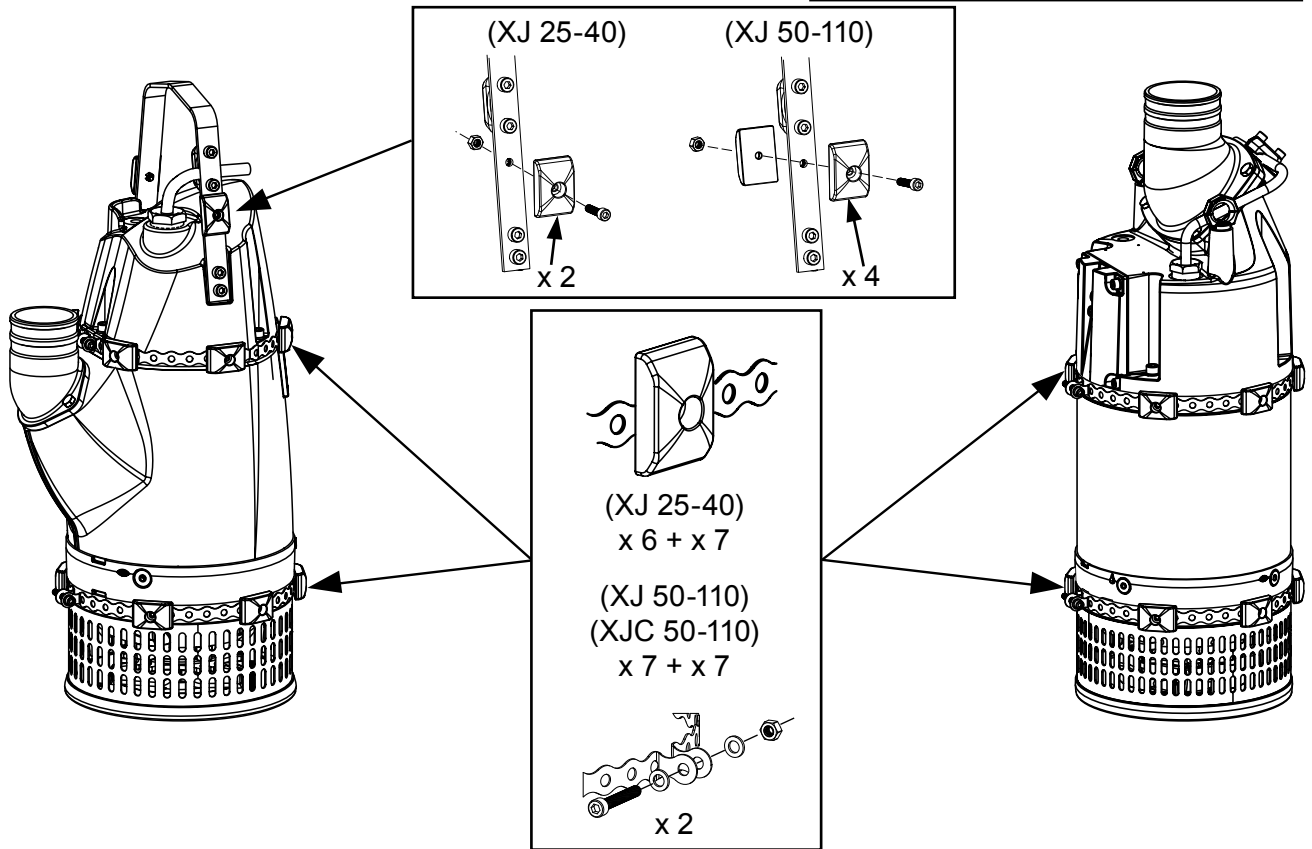
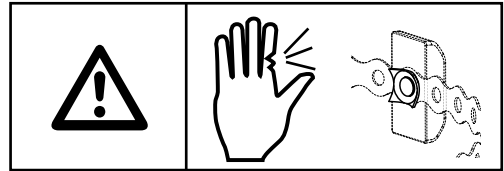

Zinc anode belt

XJS 25 - XJS 40 (P/N 00863180)

XJS 50 - XJS 110 (P/N 00863181)

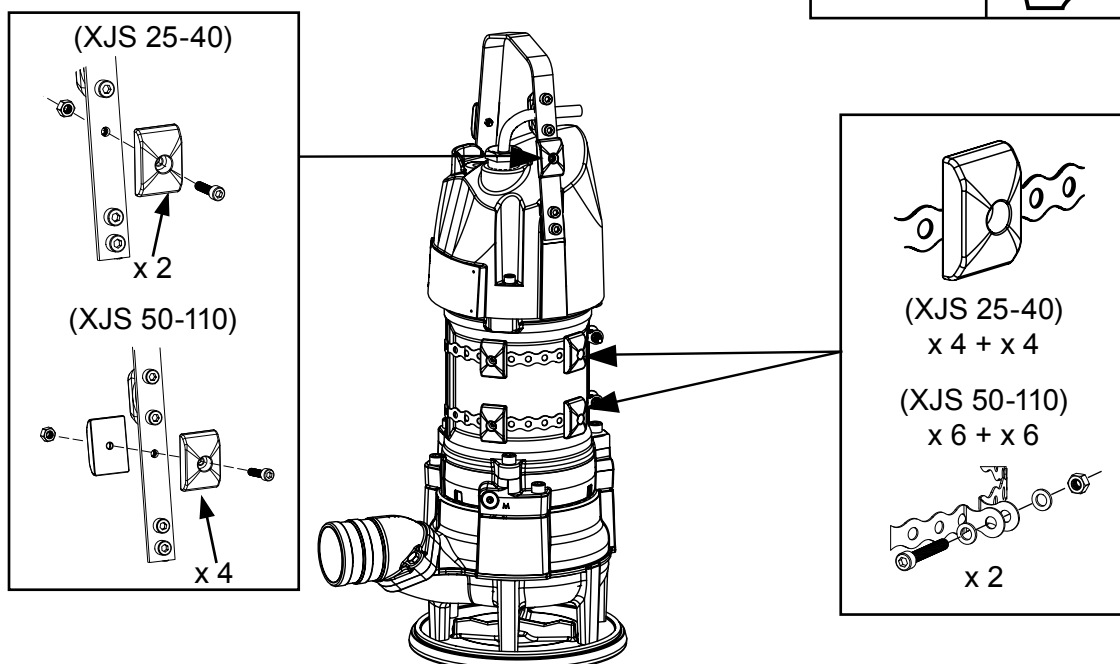
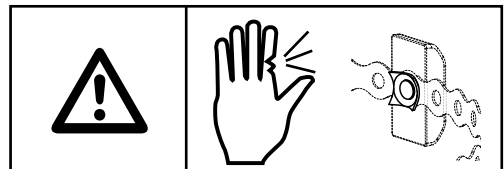

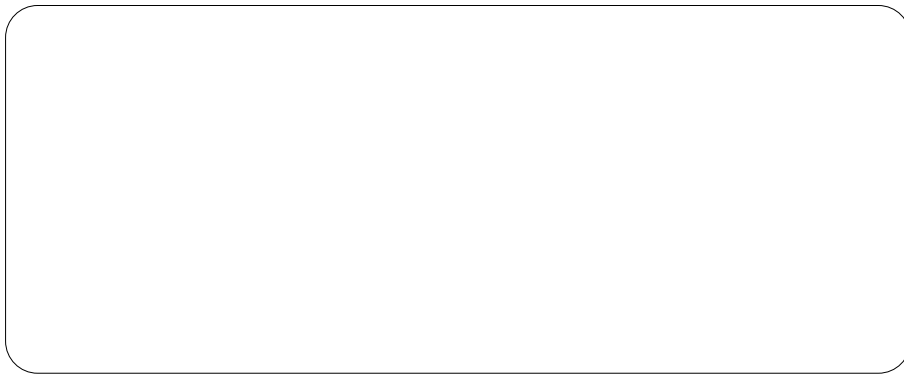

SULZER

Sulzer Pump Solutions Ireland Ltd., Clonard Road, Wexford, Ireland
Tel. +353 53 91 63 200, Fax +353 53 91 42 335, www.sulzer.com