

USER INSTRUCTIONS USE AND MAINTENANCE



LITHIUM BATTERY SAFETY CABINET COLLECTIVE PROTECTION EQUIPMENT

CONTENTS

1 GENERAL INFORMATION	6		
1.1 Manual contents and purpose	6		
1.2 Ownership of information	6		
1.3 Conventions	6		
1.3.1 Terminology conventions	6		
1.3.2 Typographical conventions	6		
1.4 Manufacturer's details	6		
1.5 Product data	6		
1.6 Technical support	6		
1.7 Liability	6		
2 SAFETY	7		
2.1 Introduction	7		
2.2 Storage and charging	7		
2.2.1 Safe storage of lithium batteries	7		
2.2.2 Active and passive storage	8		
2.3 General warnings	8		
2.4 Prohibitions	9		
2.5 Personal protective equipment (PPE)	9		
3 DESCRIPTION	10		
3.1 Fire safety cabinet	10		
3.2 Main features	10		
3.3 Structure	11		
3.4 Intended use	11		
3.5 Improper use	11		
3.6 Operating principle	11		
4 INSTALLATION	12		
4.1 Receiving the product	12		
4.2 Technical specifications	12		
4.3 Transport	12		
4.3.1 Transport conditions	12		
4.3.2 Inspection of damage caused during transport	12		
4.4 Storage	13		
4.5 Installations provided by the customer	13		
4.6 Handling	13		
4.6.1 Packaged cabinet	13		
4.6.2 Unpacked and assembled cabinet	13		
4.7 Installation site	14		
4.8 Siting	15		
4.9 Internal equipment	16		
4.9.1 Bottom collection tray	16		
4.9.2 Tray shelves	16		
5 USE	17		
5.1 Clearances	17		
5.2 Commissioning	17		
5.3 Storage	17		
5.3.1 Storage capacity	17		
5.4 Bottom collection tray	17		
5.5 Door closure	17		
5.5.1 Automatic door closer / delayed closer	17		
5.5.2 BACMY23 Safety Cabinets	18		
5.5.3 Door lock	18		
5.6 Opening the cabinet after a fire	18		
6 ACCESSORIES	19		
6.1 LITHIUMSAFE QUARANTINE	21		
6.2 4G SENSOR	22		
6.2.1 Installation	22		
6.2.2 Visual and audible signals	22		
6.2.3 Alarm test	23		
6.2.4 Silence alarm	23		
6.2.5 Troubleshooting	23		
6.2.6 Control test	23		
6.2.7 Automatic test	23		
6.2.8 Account creation and product registration	24		
6.3 GSM telephone dialler (GSM-00)	25		
6.3.1 Structure	25		
6.3.2 Specifications	26		
6.3.3 Installation	27		
6.3.4 Start and unlock screen	28		
6.3.5 Main menu and top information ribbon	28		
6.3.6 Phone book	28		
6.3.6.1 Call a contact:	29		
6.3.7 SMS	30		
6.3.8 Voice messages	30		
6.3.9 Configuration (Inputs, Outputs, Associations and Timer)	30		
6.3.9.1 Inputs	30		
6.3.9.2 Outputs	31		
6.3.9.3 Associations	31		
6.3.9.4 Timer	32		
6.3.10 Reports	33		
6.3.11 Settings	34		
6.3.12 Status screen	36		
6.3.13 Events log	36		
6.3.14 Remote commands	36		
6.3.14.1 SMS Commands	37		
6.3.14.2 DTMF Commands	38		
6.3.15 Remote programming via software	38		
6.3.16 Quick guide to Android app	39		

6.4	Automatic extinguishant controller (FPC)....	40
6.4.1	Overview	40
6.4.2	Operation	40
6.4.3	Technical data	41
6.4.4	Installation	41
6.4.4.1	Fastening	41
6.4.4.2	Connections to the circuit board	41
6.4.4.3	24V IN / 24V OUT Power Supply	41
6.4.4.4	Detection	42
6.4.4.5	Connecting powder extinguishers to activation circuit (GEN1 - GEN4)	42
6.4.4.6	Remote signalling contact (FIRE)	42
6.4.4.7	Fault relay (FAULT)	42
6.4.5	Testing and commissioning	42
6.4.6	System diagram	44
7	MAINTENANCE	45
7.1	Inspections and maintenance register	45
7.2	Routine maintenance	45
7.2.1	Daily and monthly checks to be carried out autonomously	45
7.3	Extraordinary maintenance	45
8	DECOMMISSIONING	46
8.1	After normal use	46
8.2	After a fire	46
9	DEACTIVATION AND DISPOSAL	46
9.1	Deactivation	46
9.1.1	Precautions for storage	46
9.2	Disposal	47
9.3	Information for users	47
10	TROUBLESHOOTING	47

Dear Customer,

Thank you for choosing a product from our company. You have made a decisive investment into your company's safety.

Our products make it more convenient and safe to store hazardous substances at the workplace, ensuring occupational safety requirements are met.

This instruction manual contains important information and suggestions that must be followed in order to get the best out of the product.

Many thanks again

Justrite®

BEFORE SIGNING THE TRANSPORT DOCUMENT (AS ALSO SPECIFIED ON THE PACKAGING), IMMEDIATELY CHECK THE "TILTWATCH ALERT" AFFIXED TO THE OUTSIDE OF THE PACKAGING.

IF THE INDICATOR IS RED, IT MEANS THAT THE SAFETY CABINET WAS HANDLED IMPROPERLY DURING TRANSPORT.

IMMEDIATELY INFORM THE DRIVER AND THE SHIPPING COMPANY, THEN WRITE "ACCEPTED UNDER RESERVATION" ON THE TRANSPORT DOCUMENT, EXPLAINING THE REASONS THEREOF.

WARRANTY

The manufacturer's warranty for cabinets used for storing dangerous substances lasts 36 months from the date of delivery.

These cabinets are classified as technological safety equipment and, as such, are subject, under EN and DIN standards, to **compulsory annual inspections by the authorised Technical Support Service or by persons authorised by the Head of the Prevention and Protection Service (RSSP) on account of their background, experience, training and knowledge of the relevant regulations.**

FAILURE TO CONDUCT THESE INSPECTIONS SHALL VOID THE WARRANTY.

REGULATORY REFERENCES AND CERTIFICATIONS

The product's performance standards are in accordance with EU standards EN 14470 (Type 90) and EN 16121, which set safety and performance requirements.

More specifically, the technical standard:

- EN 14470-1:2004 (TYPE 90) – Part 1: safety storage cabinets for flammable liquids
- EN 16121:2017 - non-domestic storage furniture - requirements for safety, strength, durability and stability

All models **specified in this instruction manual** have been subjected to destructive testing in a furnace. The tests were conducted in an independent accredited laboratory.

The product is certified by BUREAU VERITAS

WRITE THE PRODUCT SERIAL NUMBER HERE

RANGE

LITHIUM BATTERY STORAGE CABINETS

MODEL	Code	Description
226-LTC C-series	JCBSLC01BU	Single right door - 6 sockets
	JCBSLC02BU	Double door - 6 sockets
	JCBSLC03BU	Single right door - 10 sockets
	JCBSLC04BU	Puerta doble - 10 enchufes
226-LTD D-series	JCBSLD01BU	Single right door - 6 sockets
	JCBSLD02BU	Double door - 6 sockets
	JCBSLD03BU	Single right door - 10 sockets
	JCBSLD04BU	Puerta doble - 10 enchufes
226-LTE E-series	JCBSLE01BU	Single right door - 6 sockets
	JCBSLE02BU	Double door - 6 sockets
	JCBSLE03BU	Single right door - 10 sockets
	JCBSLE04BU	Puerta doble - 10 enchufes
226-LT	JCB22613BU	Single right door - Cabinet only
	JCB22612BU	Double door - Cabinet only
	JCB22611BU	Single left door - Cabinet only

ACCESSORIES FOR IMPROVING SAFETY PERFORMANCE

MODEL	Code	Description
226-ROLL	JCBSROLL00	Skates for cabinet movement
2903-SS	JCB60MY00	Shelves for the cabinet
	JCB120MY00	Shelves for the cabinet
2903-PO-SS	JCB60IS000	Sliding shelves for the cabinet
	JCBS120IS0	Sliding shelves for the cabinet
2903-EP	JCB60VMY00	Epoxy shelves for the cabinet
	JCB120VMY0	Epoxy shelves for the cabinet
2903-PO-EP	JCB60VS000	Epoxy sliding shelves for the cabinet
	JCBS120VS0	Epoxy sliding shelves for the cabinet
2903-PF-EP	JCBS60LS00	Perforated shelf for the cabinet - Epoxy
	JCBS120LS0	Perforated shelf for the cabinet - Epoxy
2903MC-00	JCBS60S000	Sliding shelf mechanism*
	JCBS120S00	Sliding shelf mechanism*
ACF-00	JCBRSOL000	Activated carbon filter
CSP-00	JCBCSPF000	Dust filter
EXF-NS	JCBDM125BP	Spark-free extraction fan
EXF-AT	JCBAT100BP	ATEX extraction fan
EXFL-NA	JCBCFNL000	Extraction fan with filter box - No alarm
EXFL-AL	JCBCFN0000	Extraction fan with filter box and alarm
FBN-00	JCBSFBN000	Automatic fire extinguisher kit
FPC-00	JCBSFPC000	Automatic fire extinguisher control panel
GSM-00	JCBSGSM-000	Fire safety GSM
S12-00	JCBSS12000	12-socket kit

* SHELF NOT INCLUDED

1 GENERAL INFORMATION

1.1 Manual contents and purpose



This manual describes the product, its intended use and its technical specifications.



The purpose of this manual is to provide the essential information for using and maintaining the product, to create a sense of responsibility and knowledge of its possibilities and limitations.



The people deemed suitable to carry out a determined task must have sufficient physical and mental capacity to learn the instructions given to them.



The instructions in this manual do not replace but supplement the obligations to comply with current legislation on accident prevention safety regulations.

1.2 Ownership of information

This manual contains proprietary information; all rights are reserved.

This manual may not be reproduced or photocopied, in whole or in part, without the prior written consent of **Justrite®**.

This manual may only be used by the customer to which it has been provided as an accessory to the product and solely for the purposes of installation, use and maintenance of the product to which the manual refers.

Justrite® declares that the information given in this manual is consistent with the technical and safety specifications of the product to which the manual refers.

Justrite® accepts no liability for direct or indirect harm to persons, pets or property arising from using this manual or the product under conditions other than those intended.

Justrite® reserves the right to make changes or improvements without prior notice to this manual and to the product, including where applicable to products of the same model to which this manual refers but with a different serial number.

The information given in this manual refers in particular to the product specified in "1.5 Product data" a pag. 6 Justrite®.

1.3 Conventions

1.3.1 Terminology conventions

- Product, cabinet, safety cabinet:
Lithium Battery Safety Cabinet.
- The descriptions of the orientation, direction and position (right or left of the product) refer to the position of the operator facing the main control panel.
- Qualified personnel: persons who – due to their training, experience, background and knowledge of the relative accident-prevention rules, provisions and measures and of the service conditions:
 - have been authorised by the safety supervisor to carry out any necessary activity;
 - are able to recognise and prevent potential hazards.

1.3.2 Typographical conventions

PPE: Personal Protective Equipment.

(3) or (B): Symbolic representation of a control or signalling device (for example, buttons, selectors and indicator lights) or a part of the product.



CAUTION/IMPORTANT = for important information requiring particular attention.



DANGER: for actions requiring particular caution and adequate preparation.



FORBIDDEN = for actions that **MUST NOT** be carried out.

NOTE= provides important information highlighted outside the text to which it refers.

1.4 Manufacturer's details

JUSTRITE® EMEA

Achterzeedijk 57 Unit 1, 2992SB Barendrecht,
The Netherlands
Tel: +31 180 615 744 - Fax: +31 180 611 551
E-mail: salesEU@Justrite.com

1.5 Product data

A nameplate on the product states the essential data and technical specifications.



The data shown on the manufacturer's plate must always be provided when requesting technical support and/or spare parts.

1.6 Technical support

Customers with any doubts or issues can contact the **Justrite®** authorised Technical Support Service for technical support, training and maintenance.

1.7 Liability

Justrite® accepts no liability for harm to persons, pets or property arising from failure to comply with the safety regulations and recommendations in the documentation provided.

2 SAFETY



Please read the following carefully and comply scrupulously with the instructions provided, to prevent any issues and accidents during product operation.



This manual does not replace but supplements the obligations to comply with current legislation on accident prevention safety regulations.

2.1 Introduction

As the use of lithium-ion batteries grows, the dangers arising from storing and especially charging these batteries increases, both in commercial and private settings.

The use of lithium batteries under normal operating conditions is considered safe. However, this depends on them being handled correctly.

Any technical defects or damage to the battery can rapidly lead to a critical situation. Excessively low charge levels, fires and chemical reactions are just some of the consequences that can occur.

The main causes that can lead to accidents relating to lithium batteries are:



MECHANICAL DAMAGE

In combination with the high energy density of the battery (e.g. following an impact or incident).



COMPLETELY FLAT

Causing instability, with a consequent internal short circuit and overheating of the system.



ELECTRICAL OVERLOAD

While charging or discharging (e.g. due to a manufacturing defect in the electronic protection).



THERMAL OVERLOAD

Caused by external energy or heat sources, resulting in the system overheating.

The situation becomes particularly dangerous if a lithium battery releases its stored energy in an uncontrolled manner. When the heat of the product exceeds the melting point of lithium, an uncontrollable chain reaction, or “thermal runaway”, occurs. The consequence is explosive heating of the battery.

Fires caused by lithium-ion batteries are difficult to handle and the fire spreads rapidly. Often, all that fire brigades can do is protect adjacent areas.

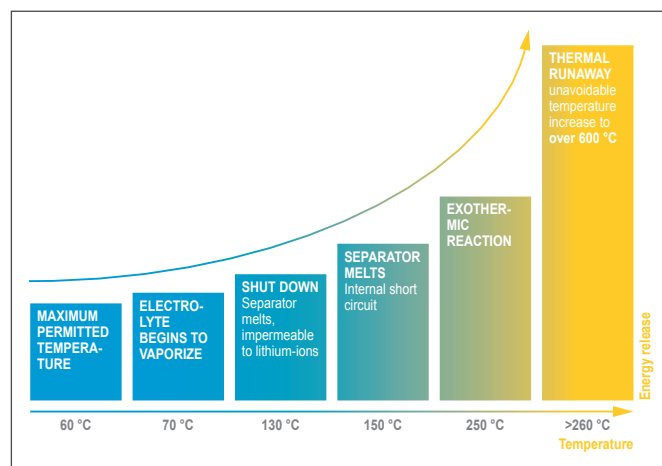

2.2 Storage and charging

2.2.1 Safe storage of lithium batteries



Avoid overloading the shelves (stay within the maximum load-bearing capacity. See “5.4 Bottom collection tray” a pag. 17 Justrite®).



Avoid stacking containers on top of one another.



Check the batteries conform to the manufacturer’s specifications (product technical sheets).



Store the batteries in a dry, well-ventilated location, at the recommended temperature to maximum battery duration.



Make sure the battery contacts cannot short circuit. Cover them with the manufacturer’s original cover or with insulating tape.



Avoid excessive vibration.



Avoid extreme temperatures and temperature fluctuations.



Do not place heavy objects on top of containers containing lithium-ion batteries.



Keep the lithium-ion cells in the dedicated containers. Tip: use ADR-approved containers to store lithium-ion batteries.



Keep the cells away from flammable and combustible materials.



Do not store large quantities of batteries if not required.



Remove damaged or defective batteries immediately from storage and production areas (from temporary storage until disposal, at a safe distance or in a separate area, with fire protection).



Keep an extinguisher specially designed for lithium-ions near the cells.

 Cooperate with the fire brigade to create safe spaces, install fire detection and suppression systems and analyse the risks in your storage space.

2.2.2 Active and passive storage

ACTIVE STORAGE (STORAGE AND CHARGING)

Active storage means the lithium-ion batteries or battery packs are charged inside the cabinet using a battery charger or, for safety reasons, partially discharged (60 - 70%) as heat is generated during charging.

Excessive heat can start a fire, for example if a charger or connection cable is faulty. Another major risk is thermal runaway caused by short circuits inside lithium-ion batteries.

The risk increases if lithium-ion batteries are left unattended and charging outside working hours. In this case, the solution is active storage inside **Justrite®** equipped with the essential accessories for increasing the internal safety performance.

PASSIVE STORAGE (STORAGE ONLY)

Passive storage is when new or used lithium-ion batteries are stored for a certain period of time.

We recommend storing new and used lithium-ion batteries separately (at different storage levels) inside **Justrite®**.

2.3 General warnings

 Carefully read in advance the safety data sheets (SDSs) of the chemicals you intend using. The SDSs must be available to the user.

 Carefully read in advance the labels attached to the batteries, especially the pictograms, hazard indications (H) and prudence advice (P) shown on them.

 Observe the laws and provisions relative to the handling of hazardous substances, as well as the notes contained in these instructions for use.

 Work on the electrical system must be carried out by specialised electricians with the power supply cut off. In this regard, also consult the relevant accident-prevention regulations, the CEI, UNI and EN standards and the regulations of the local electricity provider.

 Comply with the customer's specific installation conditions (e.g. anchorage of the cabinets to the building).

 Follow the instructions of the inspection/supervision Technical Service.

 Comply with accident prevention regulations and workplace directives. Always wear appropriate personal protective equipment (PPE).

 Make sure that the necessary technical safety inspections are carried out exclusively by the authorised Technical Support Service or by specialised and duly authorised personnel, and that original spare parts are used.

 Use the cabinet only after receiving training; unauthorised persons must be forbidden from accessing it.

 The door swing area must always be kept clear and doors/drawers must be kept closed.

 Trained/authorised specialist personnel avoid malfunctions, damage and corrosion damage caused by improper storage.

 Pay attention to the maximum limits relative to the storable quantities, stress, etc.

 Do not insert containers with a capacity exceeding the quantity that can be collected by the bottom tray. Spilled hazardous substances must be collected and removed immediately.

 Ensure adequate technical ventilation.















 Prior to commissioning, the user must examine the safety cabinet to identify any damage.

 Keep the room clean and tidy.

 Always promptly report any unsafe conditions, accidents and dangerous situations to the person in charge.

 Access to fire extinguishers, escape routes, electrical cabinets and cabinets containing shut-off and adjustment valves for fluids (technical gases, water, etc.) must be kept clear.

2.4 Prohibitions

-  Do not allow unauthorised persons to access the risk zones.
-  Do not store unidentifiable materials.
-  Do not introduce any materials and objects not pertaining to the work activity.
-  Do not store or keep food or beverages inside the cabinet.
-  Do not smoke in the workplace.
-  Do not work on your own in situations with particular risks (chemical agents, dangerous equipment or reactions, etc.).
-  Do not touch handles or other objects with the gloves used to handle the chemical agents.
-  Do not dispose of chemical substances or mixes down the drain or in paper waste bins. Solid and liquid waste contaminated with chemical agents must be disposed of according to the applicable laws and collected in appropriate containers prepared in the laboratory.
-  Do not mix waste items unless they are grouped according to similar EWC codes.
-  Do not mix hazardous and non-hazardous waste.
-  Do not install the product in places with poor or inadequate ventilation. The product is designed to be installed in appropriate locations, such as laboratories and warehouses.
-  The product must be installed, used and stored in a way that guarantees the safety of operators against potential fires or explosions.
-  Do not store substances that can cause fires and explosions due to their self-ignition properties or instability.
-  Substances with flash point below 100°C (for example, hydrogen sulphide) cannot be stored in the product situated in work environments, unless the cabinet is ventilated and the substances are stored in appropriate containers.

2.5 Personal protective equipment (PPE)



Personal protective equipment (PPE) must be worn when it is not possible to prevent, reduce or adequately address the risks with technical preventive measures.

The protective equipment for personnel includes:

- safety glasses;
- gloves compatible with the substances handled and with the tasks carried out:
 - for protection against chemical agents (including disposable);
 - for high temperatures;
 - for cryogenic liquids;
- long-sleeved lab coats with closures at the cuffs;
- slip-on safety footwear.



Specific activities or particularly hazardous substances may require additional or different PPE offering enhanced protection even when the operations are carried out with the aid of protective equipment.



This equipment may include, for example:

- protective visor;
- respiratory protective equipment.

Moreover, in order to manage chemical emergency situations (spills, leakages, etc.), the following devices are available at laboratories:

- specific protective overalls;
- full face masks;
- boots.

3 DESCRIPTION

-  It is the user's responsibility to assess the suitability of the product for their specific needs.
-  This type of product cannot be used for protection against biological risks.
-  The product is to be regarded as an actual safety device as it must ensure the health of those working in the laboratory or warehouse.

3.1 Fire safety cabinet

EN 14470-1 classifies safety cabinets according to the time it takes, under specified heating conditions, for their internal temperature to rise by 180 K without the risk of causing or fuelling a fire.

The class number indicates how long the cabinet can withstand a fire.

TYPE	TIME REQUIRED TO RAISE THE TEMPERATURE BY 180 K
30	≥ 30 min.
60	≥ 60 min.
90	≥ 90 min.

PROTECTION FROM THE OUTSIDE IN

Lithium-ion batteries stored inside **Justrite®** cabinets are protected from overheating resulting from external fires for a **period of 90 minutes**.

This prevents the batteries from burning, becoming unstable or exploding.

Fire safety tests in compliance with test conditions, under standard EN 14470-1, certify that the cabinets meet fire resistance requirements (type 90).

Safety cabinets with a fire resistance of at least 90 minutes are considered as storage areas and therefore fulfil the requirements for separate, structurally fire-resistant storage in accordance with international guidelines.

PROTECTION FROM THE INSIDE OUT

To test fire resistance from the inside out, **Justrite®** cabinets have also been subjected to fire resistance tests in compliance with EN 1363-1:2012-10. Test results show that the cabinets achieve a fire resistance of over 90 minutes.

All **Justrite®** series cabinets therefore offer excellent protection from inside out and can be equipped with a number of accessories to meet the customer's specific requirements.

3.2 Main features

The standard requires that cabinets, regardless of type, fulfil a series of specifications.

The main ones are described below:

- **Cabinets:** made entirely of 1/1.5 mm thick cold-pressed sheet steel, painted with acid-proof epoxy powder and then placed in a heat tunnel at 200°C.
- **Insulation:** high density fibre panels (without ceramic fibre) for high temperatures (800°C) and calcium sulphate panels.
- **Inner panels:** covered in melamine laminate with high resistance to vapours, including aggressive vapours.
- **Feet:** height adjustable for proper levelling.
- **Automatically closing valves:** certified 90 minutes (70°C) for air inlet and outlet pipes, located on the top and bottom of the cabinet.
- **Ventilation hole:** on the top of the cabinet, Ø 100 mm.
- **Hinges:** non-sparking, guaranteeing excellent stability and closing of the door.
- **Gasket:** DIN 4102 certified 3 cm thermo-expanding gasket.
- **Shelves:** drilled to prevent heat build-up and facilitate the dispersion of fire extinguishing powder.
- **Bottom collection tray:** (as required by EN 14470) suitable for collecting any leaks resulting from battery leakage or combustion.
- **Electrostatic discharges:** the cabinets are equipped with an earthing system which must be connected to the electrical systems' earth, so as to prevent electrostatic discharges.
- **Base:** pallet-style for easy handling.

3.3 Structure

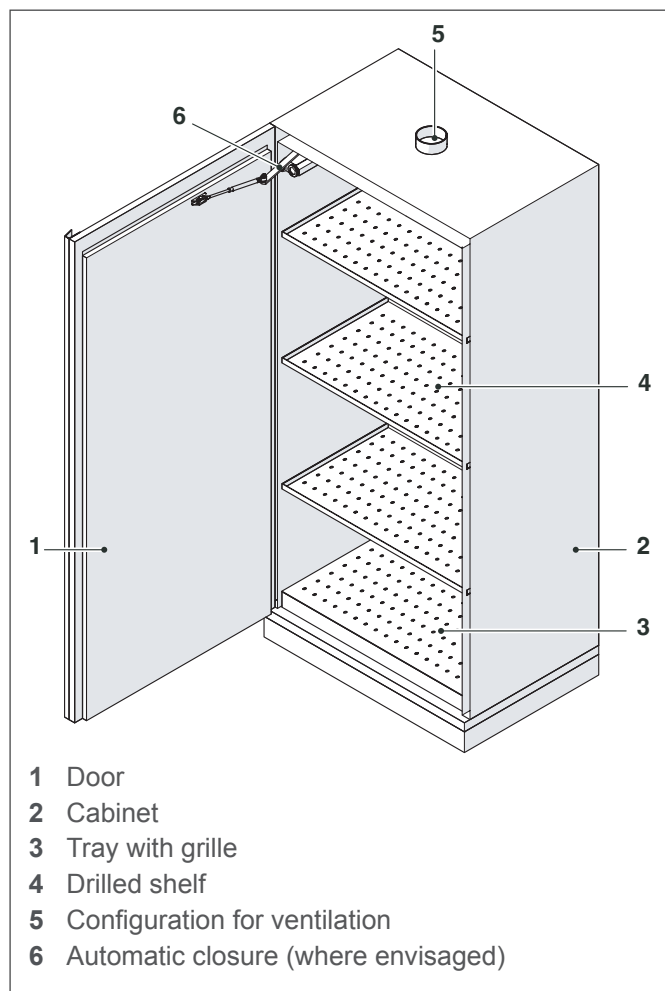

The **Justrite®** product is constructed as follows:

- Made entirely of electro-galvanized cold-pressed steel sheet with a thickness of 1 - 1.5 mm.
- Outer epoxy resin finish capable of withstanding acids and passing through a 200°C heat tunnel.
- Cabinet insulated by means of high-density rock wool panels and calcium sulphate panels.
- Inner finish consisting of melamine panels highly resistant to chemical and aggressive vapours.
- 30 mm thermo-expanding insulating gaskets which, in case of a temperature increase, guarantee the cabinet is perfectly sealed.

3.4 Intended use

Storage of lithium batteries, plus charging if equipped with a battery charging station, available (at the order stage) in Types E, F or G, with 6/12 sockets with thermal protection (220V/380V, 16A or 32A).

3.5 Improper use

Any use not stated under INTENDED USE.

3.6 Operating principle

The main purpose of the product is to safely store lithium batteries in the event of a fire for a specified period of time.

The temperature inside the cabinet during the specified time must not exceed 180°C (50°C in case of gases) to prevent explosions, allow personnel to escape and the fire-fighting and rescue teams to intervene.

PROTECTION AGAINST FIRE

- In case of fire, the cabinet must guarantee that its contents do not aid fire propagation for at least 15 minutes.

DOORS

- The cabinet doors must close fully, regardless of their current position (maximum closing time 20 seconds).
- The automatic closing devices (if fitted) must lock the doors on reaching a temperature of 47°C near the cabinet itself.
- The door closure force must not exceed 100 N.
- It must be possible to operate them with one hand only and the doors must close fully even if they are of the lockable type.

SIDE AND REAR WALLS

- The side walls and the rear wall of the cabinet must have the same thickness and structure.

VENTILATION

- The cabinets must have air inlet and outlet vents and must be designed to be connected to an air extraction system.
- The vents must close automatically if subjected to a temperature of 70±10°C.
- The ventilation system must operate continuously in a permanent manner and vent outside, in a non-risk location.
- The cabinet's pressure drop must not exceed 150 Pa.
- For a ventilated cabinet, the air exchange must be:
 - at least 10 times the cabinet's air volume per hour (when flammable substances are used).

STORAGE SYSTEMS

- The surfaces used for storage purposes must be able to withstand the load specified by the manufacturer.

LEAKAGE CONTAINMENT BASIN

- The leakage containment basin must retain its operating capacity even after the fire resistance test. This can be inspected visually by filling the tray with water.

HANDLING

- Pallet-style base for quick and easy handling. Cabinets are automatically disconnected from the mains electric during transport.

4 INSTALLATION

4.1 Receiving the product

BEFORE SIGNING THE TRANSPORT DOCUMENT (AS ALSO SPECIFIED ON THE PACKAGING), IMMEDIATELY CHECK THE “TILTWATCH ALERT” AFFIXED TO THE OUTSIDE OF THE PACKAGING. IF THE INDICATOR IS RED, IT MEANS THAT THE SAFETY CABINET WAS HANDLED IMPROPERLY DURING TRANSPORT. IMMEDIATELY INFORM THE DRIVER AND THE SHIPPING COMPANY, THEN WRITE “ACCEPTED UNDER RESERVATION” ON THE TRANSPORT DOCUMENT, EXPLAINING THE REASONS THEREOF.

4.2 Technical specifications

226-LTC - C-SERIES

DESCRIPTION	EXTERNAL DIMENSIONS) (mm)	WEIGHT (kg)
JCBSLC01BU	600x600x2070	216
JCBSLC02BU	1200x600x2070	365
JCBSLC03BU	600x600x2070	216
JCBSLC04BU	1200x600x2070	365

226-LTD - D-SERIES

DESCRIPTION	EXTERNAL DIMENSIONS (mm)	WEIGHT (kg)
JCBSLD01BU	600x600x2070	216
JCBSLD02BU	1200x600x2070	365
JCBSLD03BU	600x600x2070	216
JCBSLD04BU	1200x600x2070	365

226-LTE - E-SERIES

DESCRIPTION	EXTERNAL DIMENSIONS) (mm)	WEIGHT (kg)
JCBSLE01BU	600x600x2070	216
JCBSLE02BU	1200x600x2070	365
JCBSLE03BU	600x600x2070	216
JCBSLE04BU	1200x600x2070	365

226-LT

DESCRIPTION	EXTERNAL DIMENSIONS) (mm)	WEIGHT (kg)
JCB22613BU	600x600x2070	216
JCB22612BU	1200x600x2070	365
JCB22611BU	600x600x2070	216

4.3 Transport

The instructions given in this section must be followed when transporting the product, in other words during:

- storage
- initial installation
- relocation



Never drop / rest the product roughly as, although it is sturdy, it could get damaged and its sharp edges could ruin the floor surface.

PREVENTIVE INSPECTION OF TRANSPORT AND INSTALLATION SPACES

LOCATION	DIMENSIONS	U.M.	
LORRY	Characteristics capable of withstanding the weight of the product		
TRANSIT	Minimum height	4	m
	Minimum width	3	m
RECEPTION	Inspect the reception zone (e.g. loading ramp, flat surface)		
DOORS	Minimum height	2,30	m
HOIST	Minimum load capacity	500	kg
	Minimum height (Including doors)	2,30	m
	Minimum depth (In case of low doors)	2,30	m
	Minimum width	1,50	m
STAIRS	Minimum width	1,50	m
	Landing depth	2,20	m
Use a hoist if above the first floor			

4.3.1 Transport conditions



The product must be handled with care and always kept vertical during transport.

The product is supplied already assembled, wrapped in thermoformed material and packed on a wooden pallet suitable for being lifted with a forklift truck.

The product may be transported with the aid of industrial transport means and/or vehicles, such as lorries, with sufficient capacity for containing the product.

It must be suitably anchored to the transport vehicle (for example using ropes).

During transport, it must be protected against rain, snow, hail, wind and any other potentially adverse weather conditions. As such, we recommend using closed-body transport vehicles (vans, curtain-side lorries, etc.) or covering the product with waterproof sheets.

4.3.2 Inspection of damage caused during transport

Carry out a visual inspection to assess the condition of the product.

The “**TILTWATCH ALERT**” is applied to the packaging.

When the indicator turns red, it means that the cabinet fell or suffered a strong impact or swung excessively during transport or handling.

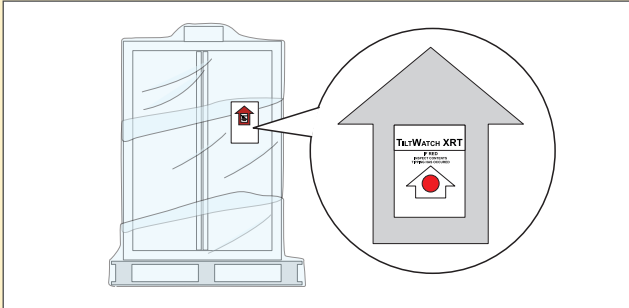

If the “**TILTWATCH ALERT**” is red, immediately inform the driver and the shipping company. The product must be inspected to assess for damage. Also remember to write “reservation” on the transport document, providing the reason. In any event, the standard procedures for dealing with complaints must be followed.

Damage caused during transport shall be attributed to the shipping company and flagged.

4.4 Storage

The instructions given in this section must be followed during temporary storage periods, which may occur in the following situations:

- the product is not installed immediately after supply;
- uninstallation and storage pending relocation.

The product must be stored and transported under the following safety conditions:

- Disconnect from power sources.
- Remove dust and foreign bodies.
- Cover with plastic sheeting.
- Store it in a dry place away from dust and contaminants.

Environmental conditions for storage

- Admissible temperature: 0°C to 35°C.
- Admissible relative humidity: 30-70 % (non-condensing)
- Adequate natural and/or artificial lighting.
- Adequate protection against atmospheric agents.
- Sufficient space for safe and easy lifting and transportation.
- Horizontal support surface with load-bearing capacity higher than the mass of parts making up the product.

Do not climb or place any object on the product.

4.5 Installations provided by the customer

The following installations must be provided by the customer:

- Workplace lighting (sufficient brightness and distribu-

tion, as laid down in current regulations).

- Connection to the mains electric.

4.6 Handling

Prior to starting handling operations, make sure that the handling and installation zones are free of obstacles and that there is enough space for moving the product and its accessories safely.

Check that the load-bearing capacity of the equipment used to handle the product is adequate for lifting the load (see “4.2 Technical specifications” a pag. 12 Justrite®).

Prior to the lifting operations, make sure that no one is in the immediate vicinity of the work zone.

4.6.1 Packaged cabinet

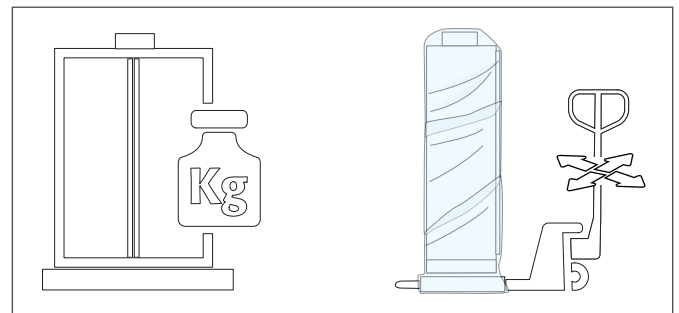

Use a pallet truck to move the product, which must be placed vertically and be secured and protected against slipping up to its final installation site.

Inappropriate handling may damage the flame insulation.

It is forbidden to use equipment with loading widths exceeding the access widths.

It is obligatory to take into account the clear opening in the base when choosing the pallet truck.

The transport protections placed in the door joints must only be removed at the final installation site.

We can only guarantee the necessary quality if the product is transported to its point of use by our specialised and adequately trained personnel.

4.6.2 Unpacked and assembled cabinet

Once its packaging has been removed, the cabinet can be handled manually. At least two specialised persons are required for handling.

It is forbidden to dispose of the packaging in the environment or leave it within reach of children as it could be potentially dangerous. It must therefore be disposed of in accordance with the applicable laws.

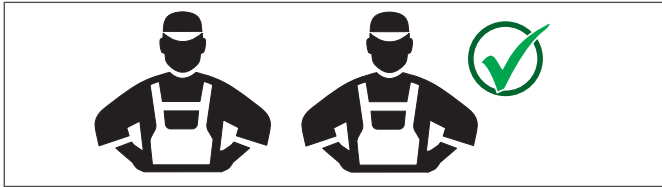

Handle the cabinet by sliding it on the pallet.

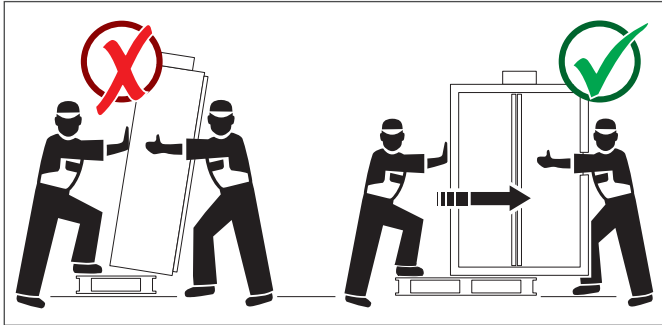

When the cabinet touches the ground, support it so that the pallet can be removed.

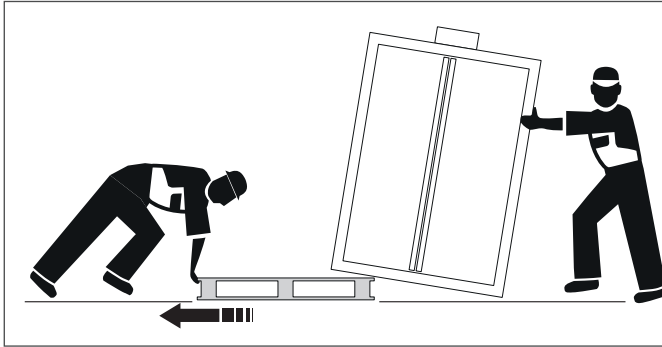

After removing the pallet, lower the cabinet slowly and smoothly to avoid damaging it.

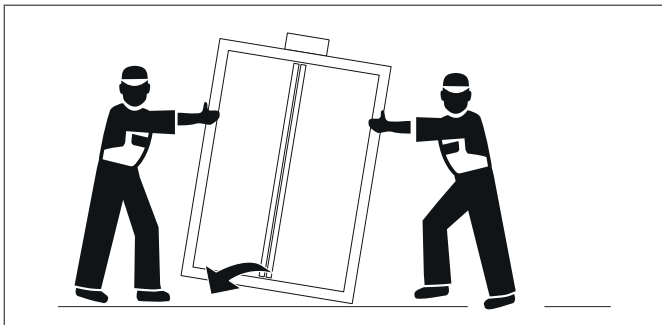

After installing the cabinet, remove the transport protections from the door joints.

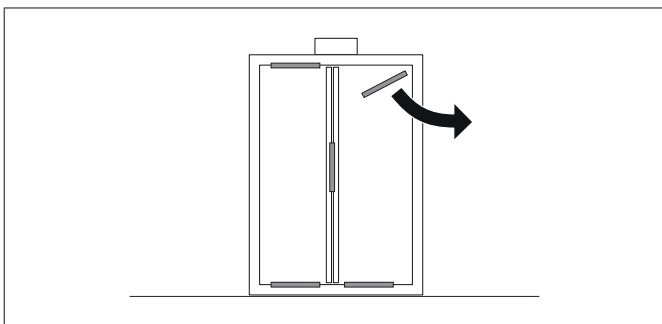

Justrite® accepts no liability for any harm to persons and/or damage to property arising from incorrectly lifting the product:

- by unauthorised or inadequately trained personnel;
- using inadequate lifting equipment;
- without following the instructions and operating procedures described in this manual.

4.7 Installation site

ZONE

The installation area must have the following characteristics:

- The area around the cabinet must be free so that the doors can be opened and the user has enough space to operate.
- A well-ventilated room (in particular for cabinets lacking a ventilation system).
- Explosions and fires cannot occur in the working environment in the event of vapour escapes from combustion liquids.
- It must not be near work stations where operations that can spark potential ignitions (e.g. grinding or welding activities) are conducted.
- There must be no risk of damage from passing vehicles.
- It must not be sited outdoors and must nonetheless be protected against direct contact with atmospheric agents.

VENTILATION



The fire-safety valves in the air supply and exhaust fittings area are important components in terms of safety and maintenance. In order to verify the efficient operation of or replace a defective component, it is important to consider that flexible connecting pipes or sliding components are used when connecting to an air expulsion system, so as to guarantee easy dismantling and reassembly of the exhaust air fitting.

With extraction system

Connect the extraction system to the fitting on the top (100 mm diameter) to allow the air to escape.

The air inlet is at the rear.

The air inlet and outlet are equipped with safety valves that close by means of a thermal fuse at a temperature of $\geq 70^{\circ}\text{C}$.

Without ventilation



The interior of the non-ventilated cabinet is regarded as a CLASS 1 sector subject to the risk of explosion. Comply with the provisions of the directives on protection from explosions, especially with regard to the prevention of electrostatic discharges.

Pursuant to EN 14470, it can be used in work environments considering the area surrounding the product as a **CLASS 2 SECTOR SUBJECT TO THE RISK OF EXPLOSION, more specifically:**

- The entire area surrounding the product for 2.5 metres and at least 0.5 metre above the floor, if there is no ventilation.
- The entire area surrounding the product for a distance of 1 metre in front of it, 0.5 metre at the sides and a height of 0.3 metre from the floor, **when there is a technical ventilation system and an exchange of air at least 5 times greater.**



If the product is made to work without connecting the exhaust air, the user must affix a marking.

SUPPORT SURFACE

The support surface must have:

- A stable, solid, flat and non-flammable surface.
- Characteristics capable of withstanding the weight of the product fully laden (see “4.2 Technical specifications” a pag. 12 Justrite®).
- Minimum ± 5 mm/m flatness.

LIGHTING

Proper lighting is necessary to ensure safe use of the product.

The product is not equipped with internal lighting; it is sufficient to ensure adequate lighting in the room.

Recommended lighting: approximately 300–600 lux.

ENVIRONMENTAL CONDITIONS

The installation area must meet the following environmental requirements:

- Admissible temperature: 0°C to +35°C
- Admissible relative humidity: 30% to 70%

POWER SOURCES

Install a power socket with an adequate earthing system near the installation area.

The connection point for the earthing system is located on the top of the cabinet, on the rear right-hand corner.

4.8 Siting



The manufacturer's responsibility is limited to the original components it has installed on the device, since any alterations or replacements cannot be controlled.



Any slight, non-structural or functional alterations relieve the manufacturer of any liability associated with faults, damage, malfunctions, etc., besides causing the immediate voiding of the certification, warranty and servicing rights.

Check that the product is in VERTICAL position (in relation to the door opening direction) and stable.

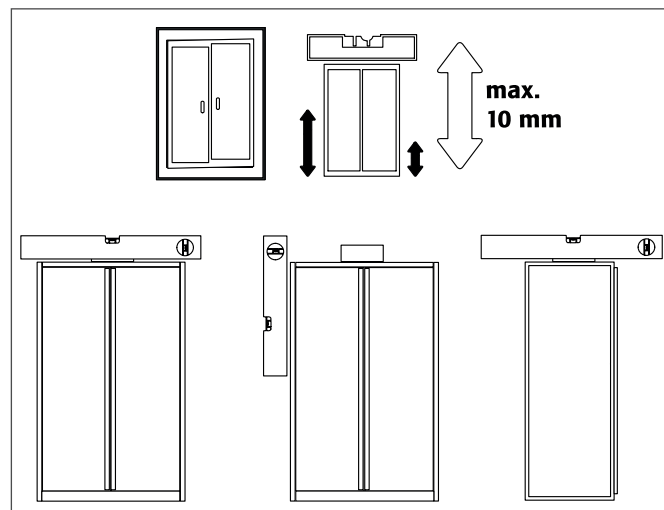

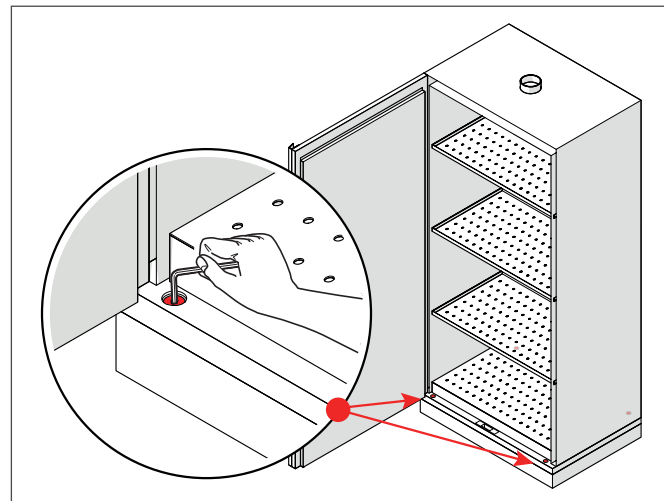

If necessary, level the product by adjusting the support feet.

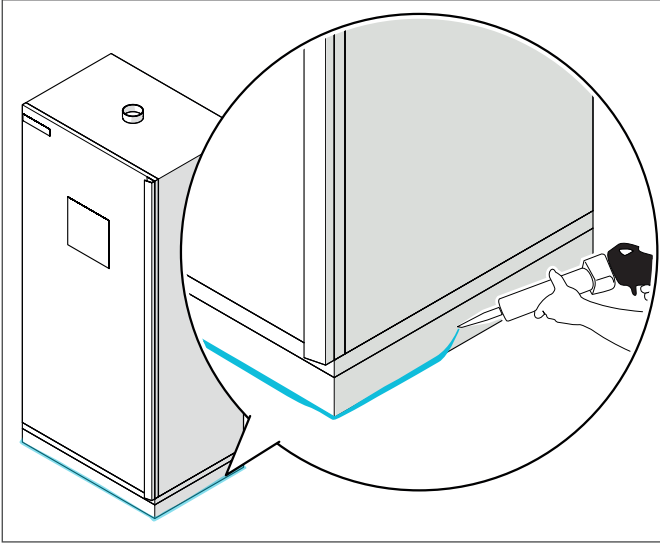

During the opening and closing phases, the door components must not drag over the fire-protection seals near the door stops. Doors equipped with automatic closing system must close automatically from any position and the lock must be lockable.

Seal the perimeter of the product base near the floor, using silicone.



 **This technical preventive measure is RECOMMENDED to prevent air and therefore flames getting under the product.**

4.9 Internal equipment

4.9.1 Bottom collection tray

 Loose parts (e.g. removable trays) must always be fully installed / inserted to guarantee safe closing of the cabinet doors in case of fire.

Pursuant to EN 14470-1: a collection tray (1) must be installed under the lowest support surface.

The collection tray (1) must have a minimum collection volume equal to 10% of all the containers (2) stored in the cabinet, or at least 110% of the volume of the single largest container (3), **whichever is greater.**

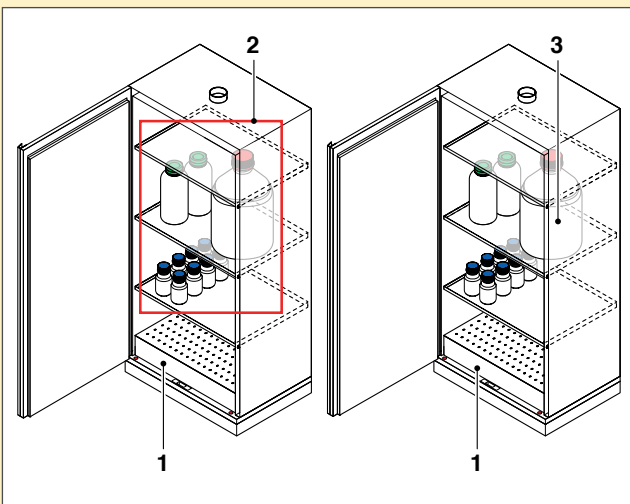

 The support surface of the collection tray (1) may only be used in combination with a perforated sheet metal component.

4.9.2 Tray shelves

Loose parts (e.g. removable trays, tray shelves) must always be fully installed / inserted to guarantee safe closing of the cabinet doors in case of fire.

 The height of the shelves inside the safety cabinets can only be adjusted by authorised coworkers, as it is necessary to guarantee the safe closing of the door in case of fire.

The shelves are secured by means of aluminium pegs to exclude any risk of sparks.

5 USE

-  Substances that are self-igniting or subject to decomposition cannot be stored!

5.1 Clearances

The opening area of the cabinet doors and drawers must be kept clear at all times of anything that may hinder their operation and use.



Never leave the doors and drawers open, nor prevent them from closing automatically, not even when there is a system that temporarily keeps the doors open.



The cabinet must be installed, used and stored in a way that guarantees the protection of all operators, particularly against the risk of fire and explosion.

5.2 Commissioning

Before the product is commissioned, the user must inspect it to rule out possible damage, and check that there are no defective or detached seals, correct orientation and efficient operation of the door components.



Only use the cabinet and its accessories if they are in perfect condition.

5.3 Storage



Lithium-ion batteries carry a risk of fire and explosion. Under certain circumstances, damaged batteries may spontaneously ignite or become unstable and explode in the presence of heat.

According to ADR (European agreement on the international carriage of dangerous goods), lithium-ion batteries are classified as dangerous materials and must therefore be handled and managed appropriately.

The main rules to be followed for proper and safe storage are:

- Conformity to the manufacturer's specifications (product technical sheets).
- Short-circuit protection of battery terminals.
- Protection from mechanical damage.
- Do not expose to high temperatures or direct heat sources or for prolonged periods of time (including direct sunlight).
- Observance of the distance (at least 2.5 m) from other flammable products if an automatic fire-prevention system is not in place.
- Remove damaged or defective batteries immediately from storage and production areas (from temporary storage until disposal, at a safe distance or in a separate area, with fire protection).
- Only store batteries with a certification test in compliance with safety standard UN 38.3 (prototypes solely in exceptional cases and with a risk assessment).
- Storage in separate areas with fire protection or a safe distance away (at least 5 m).

- Avoid storage in combination with other fire accelerants.
- Monitor the storage area with a suitable fire alarm connected to the company management services and always active.
- If a fire-prevention system is installed: compliance with the safety information given in the product safety sheets.

5.3.1 Storage capacity

The following tables specify the storage capacity of the cabinets on the basis of the series and model.

226-LTC - C-SERIES

DESCRIPTION	MAXIMUM LOAD CAPACITY *
JCBSLC01BU	60 kg
JCBSLC02BU	80 kg
JCBSLC03BU	60 kg
JCBSLC04BU	80 kg
(*) Maximum load, evenly distributed, per shelf	

226-LTD - D-SERIES

DESCRIPTION	MAXIMUM LOAD CAPACITY *
JCBSLD01BU	60 kg
JCBSLD02BU	80 kg
JCBSLD03BU	60 kg
JCBSLD04BU	80 kg
(*) Maximum load, evenly distributed, per shelf	

226-LTE - E-SERIES

DESCRIPTION	MAXIMUM LOAD CAPACITY *
JCBSLE01BU	60 kg
JCBSLE02BU	80 kg
JCBSLE03BU	60 kg
JCBSLE04BU	80 kg
(*) Maximum load, evenly distributed, per shelf	

226-LT

DESCRIPTION	MAXIMUM LOAD CAPACITY *
JCB22611BU	60 kg
JCB22612BU	80 kg
JCB22613BU	60 kg
(*) Maximum load, evenly distributed, per shelf	

5.4 Bottom collection tray

The powder coating is resistant to solvent vapours.

In case of liquid spills, the liquid must be absorbed immediately using suitable means (see www.chemisafe.it for further information).

5.5 Door closure

5.5.1 Automatic door closer / delayed closer

The doors are closed by special systems with hydraulic door closers.

During the production phase, the doors are adjusted to the right closing force and speed.

If the door closing force and speed have changed, remove the upper vertical panel to access the protective

cover of the hydraulic door closer.

 To adjust the closing speed (closing time) of each door, follow the instructions left inside the cabinet or in the bag that also contains these instructions.

The product's hinged doors close automatically thanks to the automatic door closer (see "5.5.1 Automatic door closer / delayed closer" a pag. 17 Justrite®).

A servo-assisted system, consisting of a hydraulic door closer with jointed arm, controls the closing movement with a force below 30 NW.

Each door is opened by pulling the handle.

For hands-free insertion and removal, the cabinets are equipped with a device identified by the code **PS-50MY23®**.

PS50MY23® is an automatic closing device that keeps the door open when necessary.

The stop device allows the doors to close when an ambient temperature of roughly 50°C is reached.

How to activate it:

- Pull the doors onto the stop device until they lock.
- Press the side of the door gently to close it again.

The system includes a hot-melt component consisting of two identical and symmetrical metal parts (plates) welded together with a special metal alloy. The weld melts on reaching 50°C, releasing the arm of the hydraulic door closer.

 Contact **Justrite® Technical Support for a replacement.**

5.5.2 BACMY23 Safety Cabinets

The right or left door is opened by pulling the handle.

If the ambient temperature exceeds 50°C, the doors will close automatically.

The doors are connected to a mechanical device paired with a hot-melt component, consisting of two identical and symmetrical metal parts (plates) welded together with a special metal alloy.

The weld melts on reaching 50°C, releasing the mechanical device which will automatically close the door.

 Contact **Justrite® Technical Support for a replacement.**

5.5.3 Door lock

Each door is fitted with a key-operated lock.

The lock is positioned in the centre of the door.

A key for each lock is supplied as standard.

The cabinet's serial number can be used to identify the

key's serial number.

 If the key breaks or is lost, a new one can be ordered from **Justrite® Technical Support.**

The lock automatically locks the door each time it is closed.

Once the door is open, if the key is taken out of the lock or is left half-way out (and half-way in), the lock will stay open and the door will not have to be unlocked each time it is opened.

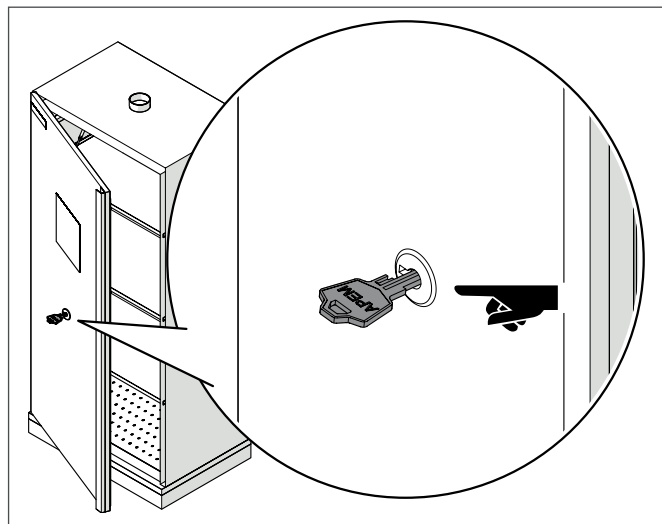

5.6 Opening the cabinet after a fire

 Depending on the duration of the fire, a flammable mixture of vapour and air may have formed.

In case of fire, inform the fire brigade on the contents of the cabinet and the circumstances that triggered the fire.

Before opening the cabinet, remove all ignition sources within 10 metres of the cabinet.

Only use non-sparking tools.

Open the cabinets with the utmost caution and **ONLY** after a period of time corresponding to **SIX TIMES** the duration of the fire, but if the surface of the cabinet is still hot to the touch, wait longer.

Keep adequate suppression devices within reach while opening the cabinet.

 We recommend laying absorbent paper and/or towels on the floor before proceeding with any operation (see www.chemisafe.it for further information).

6 ACCESSORIES



- A - Extinguisher (LSSA)
- B - Temperature sensor (fire-suppression activator)
- C - Centrifugal fan
- D - Beacon
- E - Smoke detector
- F - 4G Sensor
- G - Extinguisher (FBN)
- H - GSM telephone dialler (GSM-00)
- I - Automatic extinguishing system with FBN (FPC)
- J - Electrical sockets

A - EXTINGUISHER (LSSA)

They are non-pressurised, aerosol generators with potassium salt extinguishing powder, certified to ISO 15779:2011, EN 15276:2019 and NFPA 2010. They are an optimum fire-prevention solution due to their efficiency, cost-effectiveness (no maintenance) and virtually zero impact on equipment and facilities in the event of activation.

SPECIFICATIONS	LSSA	
Weight	1,70	kg
Extinguishing mass	0,20	kg
Coefficient of concentration	100	g/m ³
Activation current *	0,4 - 0,7	A
Protected volume	2,5	m ³
Operating temperature	-50°C...+95°C	°C
Type of output	radial	-
EN 2 fire class	A, B, C, F	-
Lifespan	10	years
(*) Electrical activation mechanism		

B - TEMPERATURE SENSOR (FIRE-SUPPRESSION ACTIVATOR)

An EN 54 certified thermal induction detector which, on detecting a temperature above that set (72°C), activates a fire-suppression system consisting of one or more powder aerosol extinguishers.

No external power supply is required for the fire-suppression activator device to function.

C - CENTRIFUGAL FAN

Centrifugal fan with power cable and activated carbon filter (not included) for 1- or 2-door tall cabinet.

Equipped with:

- Steel compartment with aluminium impeller
- Fireproof, antistatic and corrosion-resistant filter housing included in the motor housing
- Neoprene gasket for sealing

SPECIFICATIONS		
Weight	10	kg
Internal thermal protection *	55	IP
Extraction rate	200	m ³ /h
Power supply **	220-230/50	V/Hz
Outlet diameter	125	Ø mm
(*) As per standard DIN 40050		
(**) Single-phase		



It is extremely important to replace the filter regularly, or at least to check its saturation level.

D - BEACON

Acts as a visual and audible alarm for rapid emergency signalling without the need to open the cabinet doors.

E - SMOKE DETECTOR

Addressable sensor, consisting of two separate and independent detection sections.

The first section is made up of an optical smoke detector; the second has a thermo-velocimetric detector with Class A1, Suffix R (static trigger temperature 58°C). The detector is controlled by a microprocessor. The detection

algorithm guarantees maximum precision in determining the ambient temperature and in the density-based analysis of the smoke captured by the optical chamber.

F - 4G SENSOR

This product is a universal wireless optical smoke detector.

4G SENSOR is equipped with an NB-IoT module that communicates with the Foxy Cloud server.

The fire alarm is signalled by a sound, a flashing LED light and an alert to the remote Foxy Cloud server.

4G SENSOR detects smoke in the early phases of the fire, often before flames appear and the temperature rises significantly. 4G SENSOR is effective in detecting slow, smouldering fires that burn for hours before a flame develops, as well as violent fires that quickly consume flammable materials and spread quickly.

This smoke detector is designed to be installed on a wall or ceiling. It can be installed in the top of a safety cabinet to prevent fire (caused by batteries stored in the cabinet, for example) The smoke detector is designed to operate in small spaces, under normal conditions (no smoke, dust, condensed water vapour).

Also see "6.2 4G SENSOR" a pag. 22 Justrite®.

G - EXTINGUISHER (FBN)

They are non-pressurised, aerosol generators with potassium salt extinguishing powder, certified to ISO 15779:2011, EN 15276:2019 and NFPA 2010. They are an optimum fire-prevention solution due to their efficiency, cost-effectiveness (no maintenance) and virtually zero impact on equipment and facilities in the event of activation.

SPECIFICATIONS	FBN	
Weight	1,84	kg
Extinguishing mass	0,20	kg
Coefficient of concentration	-	g/m ³
Activation current *	min 1.5 / 0.8	V DC / AC
Protected volume	-	m ³
Operating temperature	-54°C...+54°C	°C
Type of output	radial	-
EN 2 fire class	A, B, C, F	-
Lifespan	15	years
(*) Thermal/electrical activation mechanism		

H - GSM TELEPHONE DIALLER (GSM-00)

Dedicated GSM dialler for the FIRE/SAFETY sector. The device's outputs can be associated with alarm events or managed remotely. Customised profiles can be created for each of the numbers entered. 2.8 inch LCD touch-screen display. The graphical interface allows quick and easy installation and is very user-friendly. The icons are similar to those used on mobile phones, allowing data to be entered intuitively and easily. The Report icon allows programmed settings to be thoroughly checked. The internet connection can be made via a fully remotely manageable security procedure, allowing the device to be programmed remotely, to see the events log or to activate outputs. The device constantly monitors its operating status (signal level, power supply, correct internal

operation) and is able to restart in fault situations without any external intervention. This guarantees a greater level of safety. If the GSM signal fails, one of the outputs can be programmed to signal the failure.

Also see “6.3 GSM telephone dialler (GSM-00)” a pag. 25 Justrite®.

I - AUTOMATIC EXTINGUISHING SYSTEM WITH FBN (FPC)

Automatic suppression systems are irreplaceable in fire protection of premises. The automatic suppression control system operates by detecting the presence of fire and controlling the discharge of extinguishant in order to limit fire damage as much as possible.



The automatic suppression system includes the fire detection system, the suppression control system, and the condensed aerosol generators.

The control unit is easy to programme and use following the instructions on the front display. The siren activation delay, the suppression activation delay, the discharge time, and the suppression duration can be programmed for greater flexibility. A manual discharge button is located on the front of the control unit and buttons for stopping and cancelling the suppression can be connected. The control unit's suppression output can activate two solenoids or more pyrotechnic actuators. The remote panels have a display showing the system status, and the extinguishant discharge activation button.

Also see “6.4 Automatic extinguishant controller (FPC)” a pag. 40 Justrite®.

J - ELECTRICAL SOCKETS

Battery charging station. Available in Types E, F or G, with 6/12 sockets with thermal protection (220V/380V, 16A or 32A).

6.1 Justrite® QUARANTINE

Patented safety cabinet (WO 2023/218338 A1) for the active and passive storage of lithium batteries, which QUARANTINES the product in case of fire.

The system is applicable to one- or two-door cabinets but can also be installed in open cabinets (with no hinged doors).

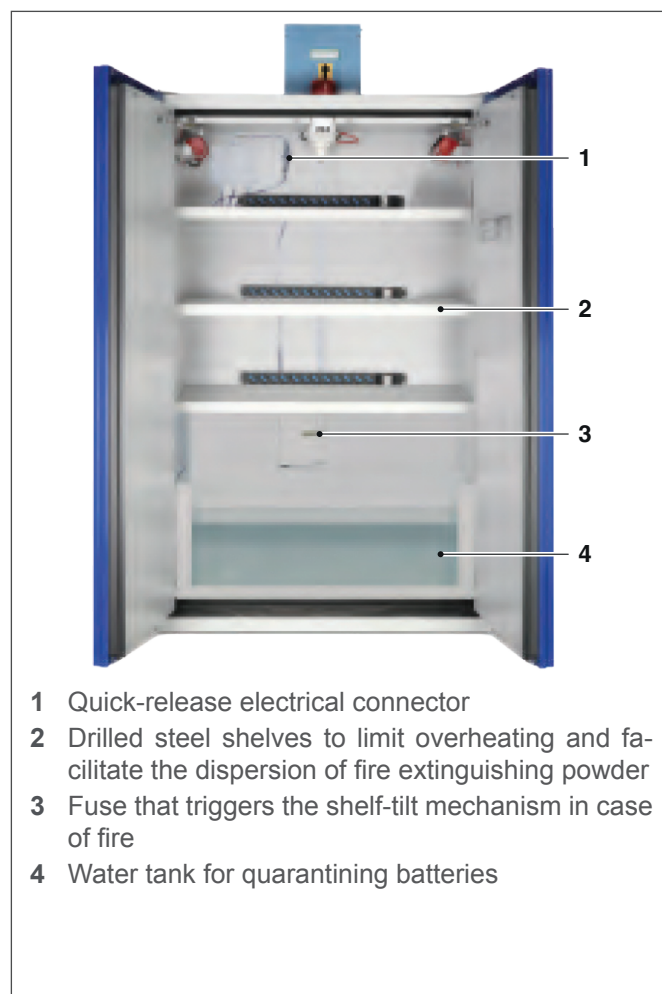

- 1 Quick-release electrical connector
- 2 Drilled steel shelves to limit overheating and facilitate the dispersion of fire extinguishing powder
- 3 Fuse that triggers the shelf-tilt mechanism in case of fire
- 4 Water tank for quarantining batteries

Operating principle

If it is the batteries that catch fire, the fire would be very difficult to extinguish due to the chemicals contained inside that fuel the flames.

Once extinguished, the fire could reignite.

To address this obvious issue, we have developed and patented an automatic system that, in the event of a fire, tilts the shelves holding the batteries so that they fall into a tank of water at the base of the cabinet.

The stored batteries, which may be connected to the charging docks, fall by force of gravity, disconnecting the main electrical socket in order to completely cut off the power supply.

Holding (or quarantining) the batteries in the tank of water not only extinguishes the fire but also prevents the possibility of further self-combustion.



- 01** If a fire starts inside the safety cabinet.
- 02** If a fire starts, our patented system automatically tilts the shelves, causing the batteries to fall into the tank of water at the base of the cabinet and simultaneously disconnects the main electrical socket.
- 03** Holding (or quarantining) the batteries in the tank of water not only extinguishes the fire but also prevents the possibility of further self-combustion.

6.2 4G SENSOR

Stand-alone, easy to use, long-lasting battery, internal siren, alerts via SMS, email, call, voice message via wireless connections on NB-IoT/CatM (LoRaWan/Sigfox optional, contact our research and development department). Over 3 years in standby, extremely simple installation.

Automatic test run every 30 seconds by the device and automatic test communication by Foxy Cloud Server every day. Optional remote button for Mute mode. Easy management of devices and alerts with the Foxy Cloud Server platform.

SPECIFICATIONS	
Dimensions	130 x 35 mm
Alarm sound	80 dB at 3 metres
Weight	160 gr
Operating temperature	-10°C ... +60°C
Battery	3.6V 3500mAh non-rechargeable
Battery duration	up to 3 years
Operating humidity	10% ... 93% NC
Self diagnostic	Yes
Network	4G NB-IoT CAT-M
SIM card	4G provided global coverage
Smoke detector	optical
Installation	ceiling
Built-in temperature and humidity sensors. The siren in the device and remote can be deactivated directly from the server.	

6.2.1 Installation

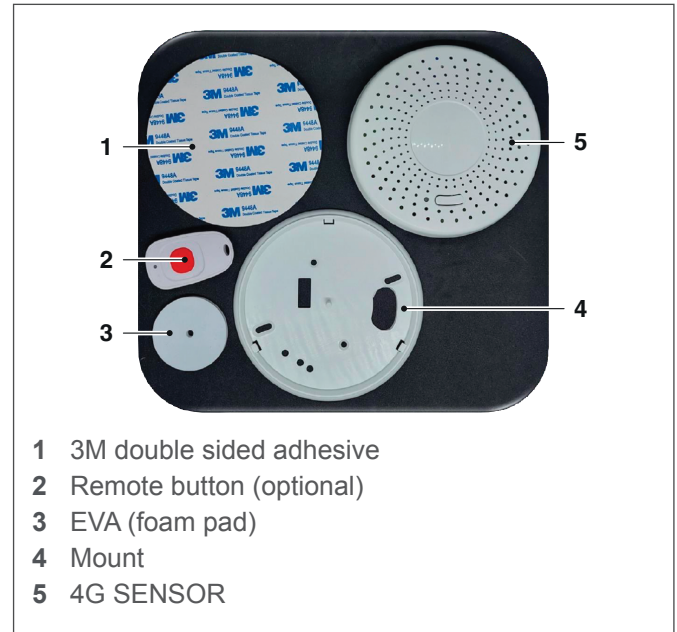

- Unscrew the base (4) of the sensor (5) by turning it anticlockwise.
- Remove the EVA insulating foam (3) between the sensor and the base.
- Screw the base (4) back onto the sensor (5), turning it clockwise; a beep signals it is positioned correctly.
- Wait 2 minutes for the conclusion of the installation: 4G SENSOR CONNECTED.
- Install 4G SENSOR inside the product at the top.
- The internal siren will sound in the event of a smoke alarm.
- Wait 30 seconds to allow the alerts to be sent (phone, SMS, EMAIL).
- (phone, SMS, EMAIL)
- To stop the siren, unscrew the sensor

Note: to receive events and alerts, the sensor must be registered and activated in your Foxy Cloud Server account. See "6.2.8 Account creation and product registration" a pag. 24ustrite@.

6.2.2 Visual and audible signals



- 6** Signalling LED
- 7** Test / Mute button

DESCRIPTION	LED	SIREN
Power on	The red LED flashes once, the green LED stays on for 10s (startup).	The siren sounds once.
Normal operation	The red LED flashes every 40s in standby, while the green LED flashes every second when the sensor is working.	The siren does not sound.
Test	The red LED flashes for 6s.	The siren sounds 3 times.
ALARM	The red LED flashes rapidly.	The siren sounds 3 times every 5s.
Mute	The red LED flashes rapidly.	The siren does not sound.
Malfunction	The red LED flashes twice every 40 seconds.	The siren sounds twice every 40s.
Low power	The green LED flashes every 5s.	The siren does not sound.

Note: 4G SENSOR is able to detect faults autonomously. As explained, the device runs a test every 30 seconds. If an operating issue is detected (e.g. smoke in the cabinet), an intermittent sound is generated.

6.2.3 Alarm test

To check the sensor is working correctly, press the test button (7) on the front (for 3 seconds). If the device is working correctly, it beeps (3 times) and the LED (6) flashes red (for 6 seconds).

If no sound or alert is generated, see section “6.2.5 Troubleshooting” a pag. 23 Justrite® to find a solution.

6.2.4 Silence alarm

While the sensor is in alarm status, the test button (7) or the remote control button (2) can be pressed to silence the siren for approximately 90 seconds.

If the red LED keeps flashing once a second, the smoke sensor is in MUTE mode.

The smoke sensor automatically resets after approximately 90 seconds.

If combustion particles or smoke are still detected after this period, the sensor beeps again (new alarm).

6.2.5 Troubleshooting

DESCRIPTION
The alarm does not sound during the test: check if the red LED flashes every 40 seconds, if so contact technical support.
The green LED flashes every 5s: the battery is flat and must be replaced, contact the retailer.
The sensor makes a sound every 40 seconds: clean the sensor with compressed air, if the fault persists, contact the retailer for a replacement.
Intermittently triggered nuisance alarms: clean the sensor with compressed air, move the sensor to a new location.
No notification or alarm received on Web Cloud server: device is not under 4G network coverage, move the device to another location.
No email notification received: check that the Foxy Cloud account administrator’s email is correct (and not blocked by antivirus or in spam folders).

6.2.6 Control test

Note: the sensor must be registered and activated in your

Foxy Cloud Server account. See “6.2.8 Account creation and product registration” a pag. 24 Justrite®.

COMMUNICATION TEST BETWEEN SENSOR AND FOXY CLOUD SERVER

This test confirms the sensor is working, especially the communication between it and the Foxy Cloud Server.

To test the sensor is working correctly, press the test button (7) on the front (for 3 seconds). The sensor beeps 3 times and the LED (6) flashes red for 6 seconds.

A few moments later, a “Test Button” event (code 356) should appear in the Foxy Cloud Server account and the account administrator should receive a notification (email).

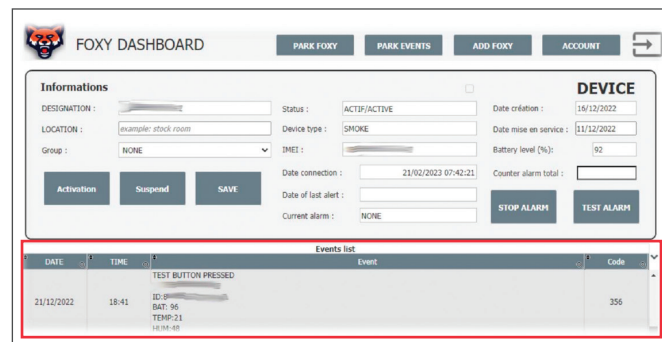

COMMUNICATION TEST BETWEEN FOXY CLOUD SERVER AND SENSOR

On the device page in the Foxy Cloud Server customer area, click the “TEST ALARM” button to run a communication test with the sensor (a dialogue box opens with the device).

On receiving the request, the sensor beeps twice and sends confirmation to the server. A few moments later, an event should appear in the Foxy Cloud Server account and the account administrator should receive a notification (email).

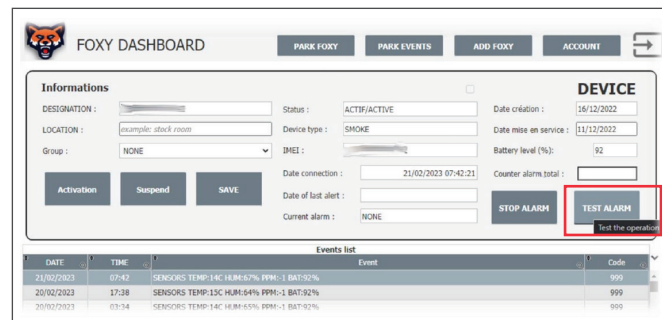

6.2.7 Automatic test

Note: the sensor must be registered and activated in your Foxy Cloud Server account. See “6.2.8 Account creation and product registration” a pag. 24 Justrite®.

The Foxy Cloud Server platform monitors sensor communications; if a device does not communicate for over 24 hours, the account administrator will receive a notification (email) with an event associated with the device. The device monitors the status of its sensor every 30 seconds. In the event of a fault, a signal is activated (beep every 40 seconds).

Each sensor communicates its status to the Foxy Cloud Server via one or more daily connections.

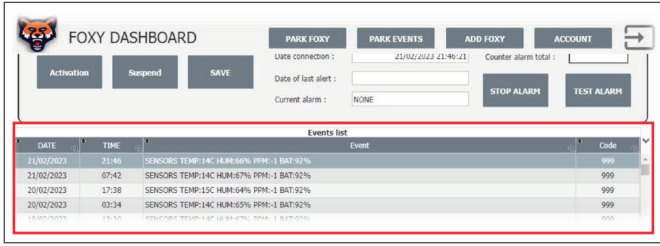

6.2.8 Account creation and product registration

The Foxy Cloud Server WEB platform allows the devices, contacts, alarms, chronology and events of associated devices to be administered.

From a web browser (desktop version), go to:

- <http://foxy.innovmobile.com/>
- create or log in to your account.

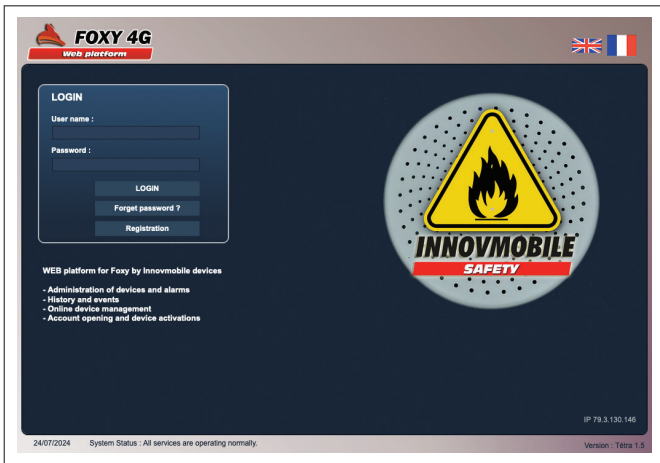

DEVICE REGISTRATION

If the sensor is NOT on the Devices list, click “ADD FOXY” and follow the instructions. Once registered, the device is active on the platform and events and alerts can be received from the sensor.

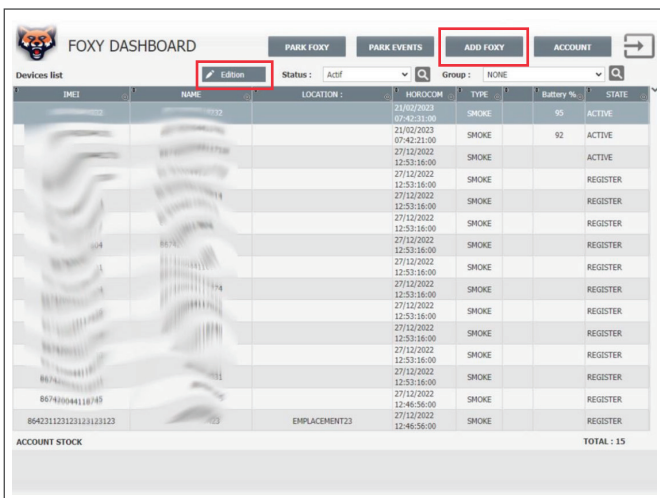

If the sensor has been registered but is NOT yet active, it appears on the Devices list in REGISTER status.

To activate it:

- select the desired sensor from the list;
- click “Edition”;
- click “Activation”.

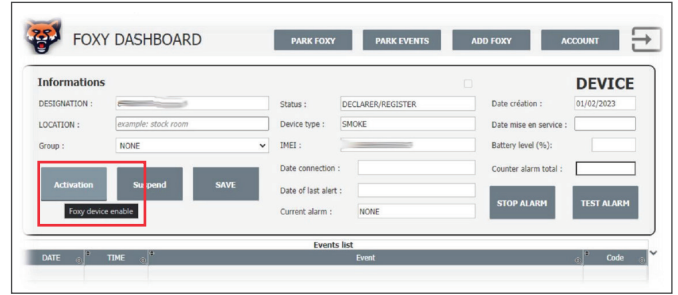

MANAGE ALERTS AND CONTACTS

By default, the account administrator receives the alerts and alarms relating to connected and activated sensors. Other contacts may be added, who will also be informed of alarms from 4G SENSORS.

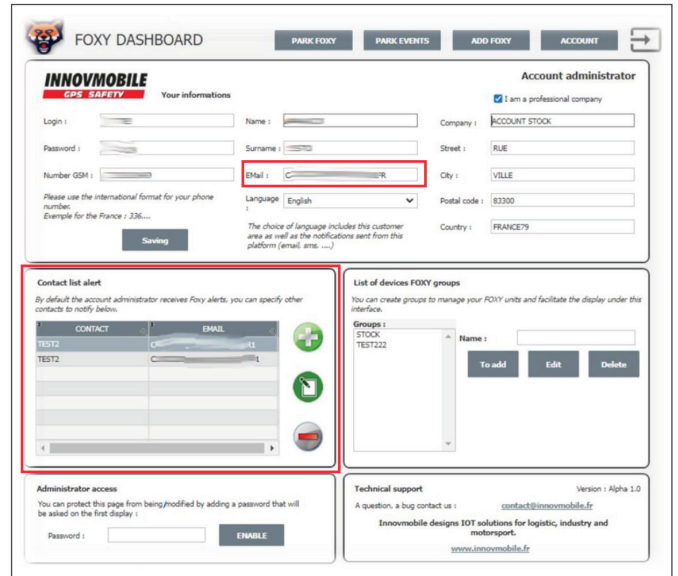

6.3 GSM telephone dialler (GSM-00)

The **GSM-00** is a latest-generation telephone dialler that teams ease of use with cutting-edge technology in workplace safety.

This device has 6 programmable input lines and 4 relay output lines and offers a comprehensive range of customisations, making the **GSM-00** one of a kind and ideal for any kind of installation.

The **GSM-00** is able to react to a series of events (triggers), to which the user can associate a chain of actions to be carried out by the dialler each time the event occurs. For each trigger (6 physical inputs, low battery, power failure, incoming call), the telephone dialler allows a chain of twenty-five possible reactions to be programmed, including activation of outputs, send SMS and voice calls.

Saved actions will be carried out at each trigger, allowing not only customised events but also the possibility of associating several events with the same trigger. With basic knowledge of the device, sequences of automated events can be created which can also be triggered via the device's remote commands.

6.3.1 Structure

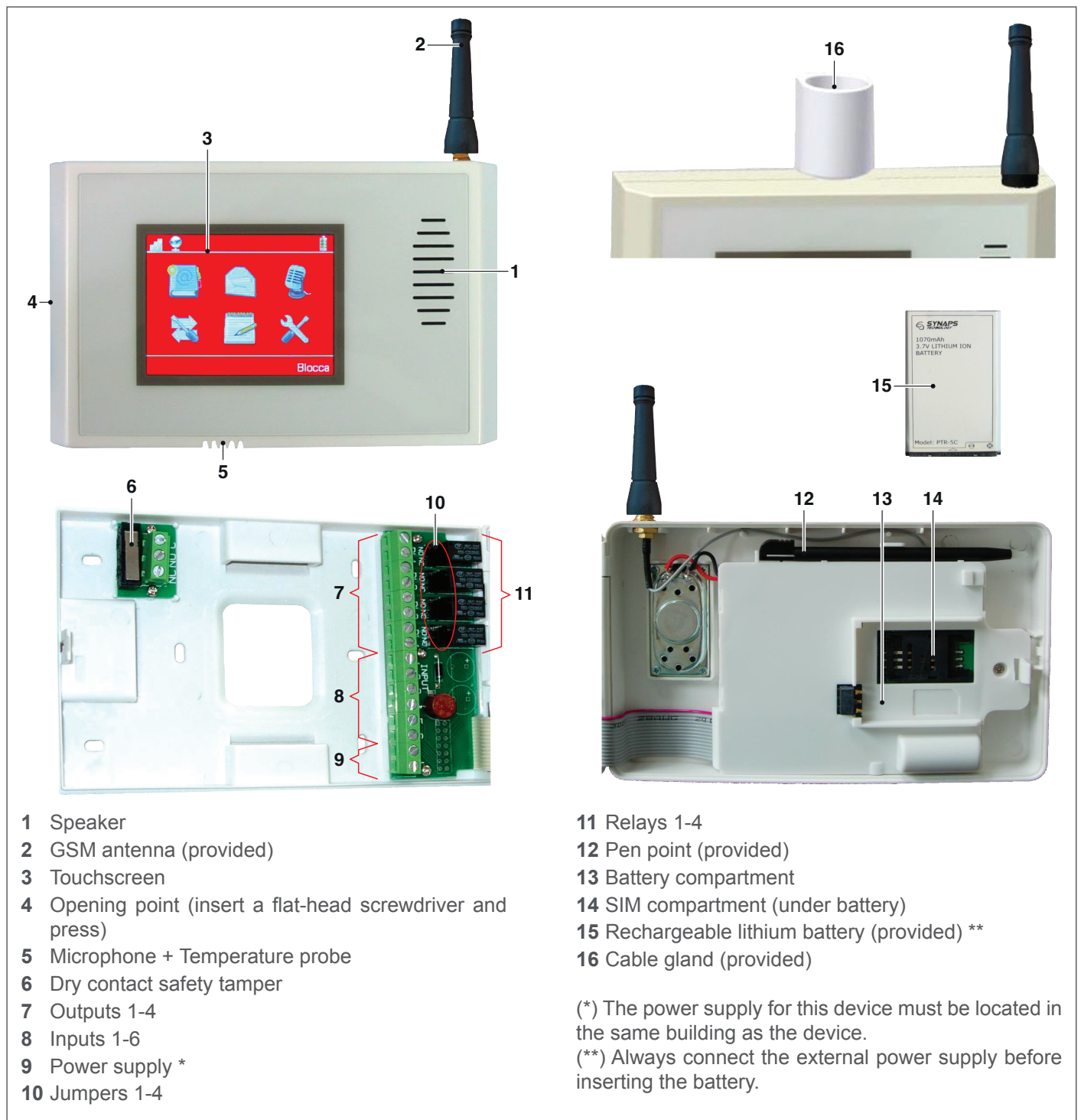

- 1 Speaker
- 2 GSM antenna (provided)
- 3 Touchscreen
- 4 Opening point (insert a flat-head screwdriver and press)
- 5 Microphone + Temperature probe
- 6 Dry contact safety tamper
- 7 Outputs 1-4
- 8 Inputs 1-6
- 9 Power supply *
- 10 Jumpers 1-4

- 11 Relays 1-4
- 12 Pen point (provided)
- 13 Battery compartment
- 14 SIM compartment (under battery)
- 15 Rechargeable lithium battery (provided) **
- 16 Cable gland (provided)

(*) The power supply for this device must be located in the same building as the device.

(**) Always connect the external power supply before inserting the battery.

6.3.2 Specifications

DESCRIPTION	
Dimensions	Plastic case dimensions without cable gland: - Height: without antenna 99 mm; with antenna provided 143 mm. - Width: closed 147 mm; open to 180° 288 mm; open to 90° 164 mm. - Depth: 36 mm.
Power supply	10.5 V to 30 V direct current.
Input	In standby: display on 90 mA; display off 30 mA. In alarm: call 150 mA (max 300 mA during GSM peaks); outputs 20 mA with relay activated.
Operating temperature	0°C to 45°C.
Operating humidity	Non-condensing.
IP rating	IP31C.
Battery	Internal, with 15 hours autonomy. Only use PTR-5C or BL-5C lithium-ion batteries.
Numbers stored	Up to 1000 phone numbers. Activation of each output individually settable for each contact. Forwarding of messages received on specific contacts. Allows hands-free conversation with enabled contacts.
SMS stored	25 text messages each up to 160 characters in length. Programmable in concatenation.
Voice messages	6 voice messages each lasting 20 seconds. Possibility of replaying the recorded message in hands-free mode.
Outputs	4 programmable relay outputs with continuous or pulse activation. Contacts can be "Normally open" and "Normally closed", selectable via Jumper. Programmable duration of pulse outputs. Relay voltage limit 30V - 1A MAX.
Inputs	Minimum voltage 0V. Maximum voltage equal to that of the external power supply. 6 programmable inputs to respond to a variety of triggers. Events activated by "Normally open" and "Normally closed" contact, both positive and earth.
Events managed	6 events activated by respective inputs. No DC line event. Battery flat event. Incoming call event.
Tamper-proofing	Anti-opening tamper and anti-removal tamper, with 3-pole terminal board, for connecting to a control unit or to an input. Voltage limit of tamper-proofing switches 50V MAX.
Programming	Locally via touch screen. Remotely via software provided: DS 100 Programmer.
Outputs control	Remotely via SMS. Remotely during an alarm phone call.
Additional functions	Possibility of control via SMS (credit control, status request). Possibility of control via DTMF tones. Time programmer. Auto-compiling function. Events log (up to 1000 events stored). Hands-free user call function.
Providers supported	TIM; Vodafone; WindTre; and derivatives.

 Risk of explosion if the battery is replaced with an incorrect type.

 Dispose of used batteries in accordance with the instructions.

6.3.3 Installation

Output jumper (10)

Move the jumper to select NO or NC for each output.

Outputs (7)

OUT1; OUT2; OUT3; OUT4:

2 terminals for each NO - NC output selectable via jumper.

Inputs (8)

Terminals 1 to 6 the connection must be made according to the configurations set on the device.

Power supply (9)

10.5 V min; 30 V max direct current.

Connect the power supply first and only then insert the battery into the compartment.

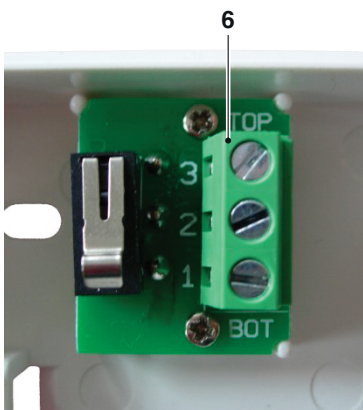
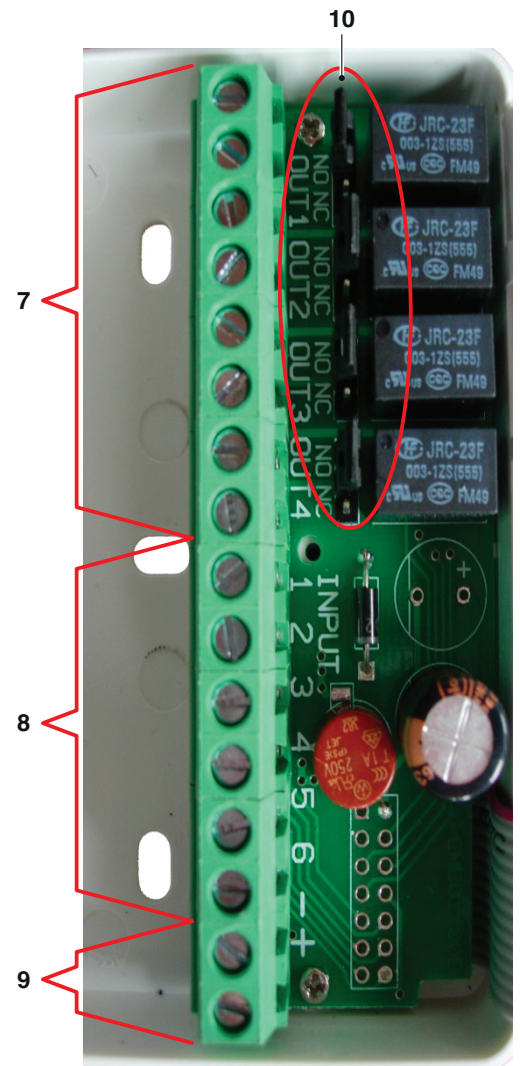

2 safety tamper (6)

Connect contacts 3 and 2 for the anti-opening tamper.
Connect contacts 2 and 1 for the anti-removal tamper.
Connect contacts 3 and 1 for both tamper.

Connecting contacts 3 and 1 activates the monitoring of both tamper.

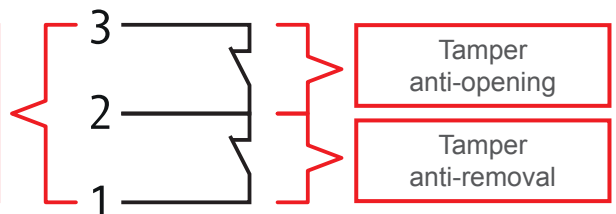

The **GSM-00** can be powered by the internal buffer battery alone for the time needed for configuration. Once programming is complete, remove the battery and connect the dialler to the external power supply. If the buffer battery is particularly low or flat, a direct connection with the battery inserted can damage the device.

Proceed as follows for correct installation:

- 1 Remove the internal battery (15).
- 2 Connect the negative power supply terminal.
- 3 Connect the inputs and outputs.
- 4 Connect the positive power supply terminal.
- 5 Insert the internal battery.

6.3.4 Start and unlock screen

To prevent damage to the equipment, power the dialler by connecting the direct current first, and then inserting the battery.

If the dialler keeps restarting when switching on during the GSM registration phase, remove the SIM to allow it to start and make sure the battery is sufficiently charged (tap "Status" on the main screen and check that the battery shows a value above 3.7V). If not, the battery must be charged with the SIM removed.

On switching on, the **GSM-00** starts the GSM registration procedure. The user must wait for the process to finish. Whether or not the device succeeds in connecting, it will continue normally to the unlock screen.

 Deactivate the request for the SIM card pin; otherwise the GSM-00 will not connect.

The unlock screen has an information ribbon at the top (described below) and a date and time ribbon at the bottom.



To unlock the dialler, tap the padlock in the centre of the screen and enter the administrator password (default setting "12345") using the touch keypad. Then tap confirm in the bottom right corner.

If logging in with the user password (default setting "54321"), the following functions will not be available: Inputs; Outputs; Associations; Voice messages.

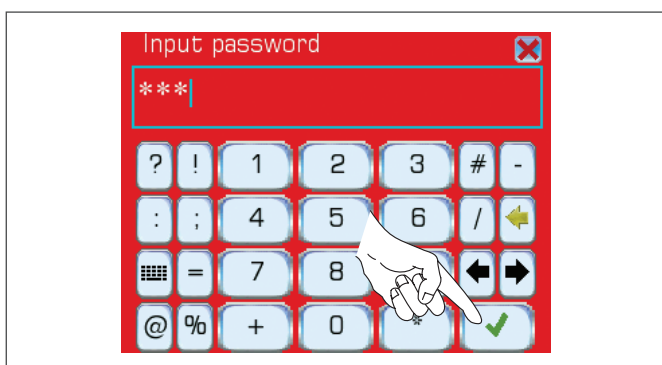

If you have difficulty entering your password, or entering any text via the input screen, you may need to recalibrate the touch-screen.

To recalibrate, tap the icon at the top left, then follow the instructions for each of the 4 corners of the screen.

 The administrator password should be changed for security reasons.

6.3.5 Main menu and top information ribbon

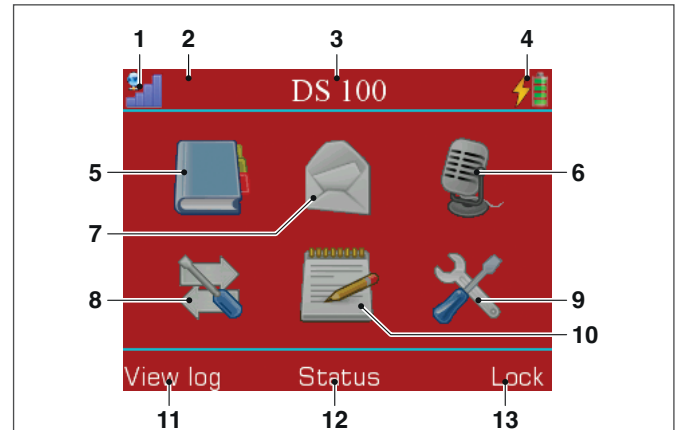

- 1 GSM network quality
- 2 GPRS connection present or absent
- 3 The screen name (e.g.: Actions List) in the relative sessions or the name of the telephone provider if in lock screen (e.g.: I TIM)
- 4 Battery charge level, which also displays a lightning bolt if connected to an external power supply.
- 5 Phone book
- 6 Voice messages
- 7 SMS
- 8 Inputs, outputs, associations and time programmer
- 9 Configurations
- 10 Reports
- 11 For accessing the events log
- 12 For accessing the status screen
- 13 For returning to the lock screen

6.3.6 Phone book

In the **main Phone book screen** you can:

- Create a new contact (using the "New" key).
- Edit a contact (selecting one and then tapping "Edit").
- Delete a contact (selecting one and then tapping "Delete").
- Call a contact (by double tapping the selected contact).
- Return to the main menu (tapping "Back").

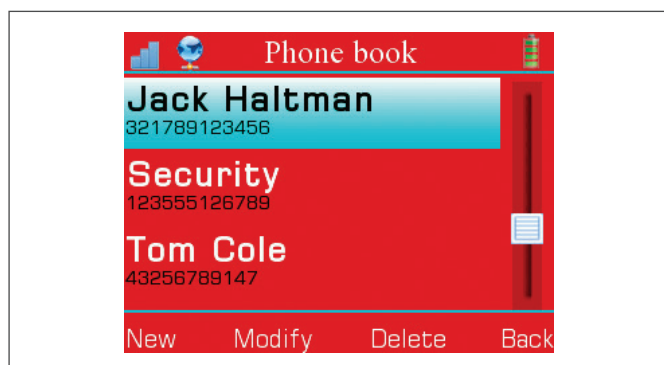

Create or edit a contact:

- Enter the name of the contact using the touch keypad.



- Enter the number of the contact using the touch numeric keypad.

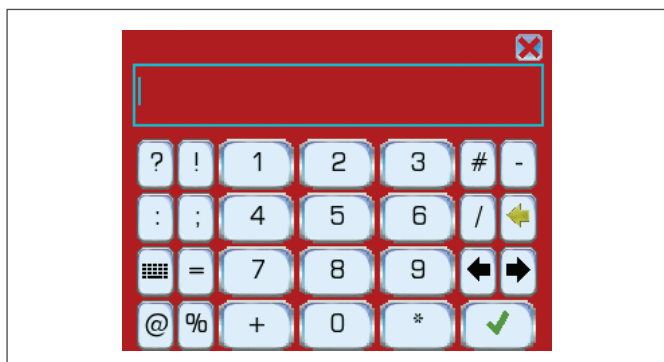

- Select the desired contact settings (described below) by ticking the relative boxes.

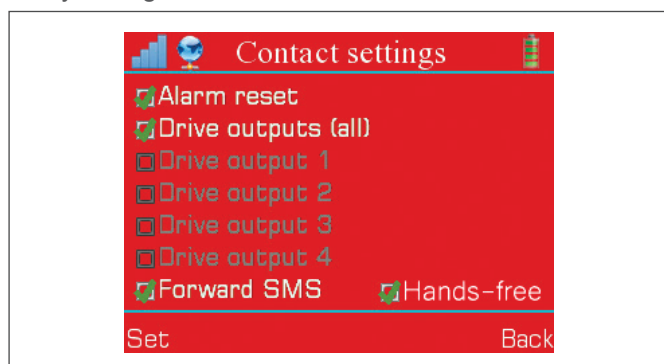

The contact settings are for assigning special remote control privileges to some contacts or forwarding messages the **GSM-00** receives to the corresponding number:

- **Alarm block (Reset):** enables the contact to block the alarm remotely (SMS and DTMF reset commands, see section "6.3.14 Remote commands" a pag. 36 Justrite®).

mends, see section "6.3.14 Remote commands" a pag. 36 Justrite®).

- **Control all outputs:** activates all output commands (including those not selected).
- **Control output 1-4:** allows the contact to activate the relative output remotely.
- **Forward SMS:** sends the contact all SMS messages not relating to remote commands that the **GSM-00** receives from numbers not in the phone book (Useful if wishing to receive SMS messages that the **GSM-00** receives from your phone provider to your phone number, as in the case of remaining credit SMS).
- **Enable hands-free response:** the enabled contact, if included in a send voice message action, can talk hands-free during the alarm phase with the person at the **GSM-00** after listening to the forwarded recording 4 times.

6.3.6.1 Call a contact:

All contacts in the phone book can be called using this function (with no "Contact settings" limit).

- Double tap the selected contact to call them.
- During a call, other actions cannot be carried out on the device; press "Ok" in the pop-up to end the call.

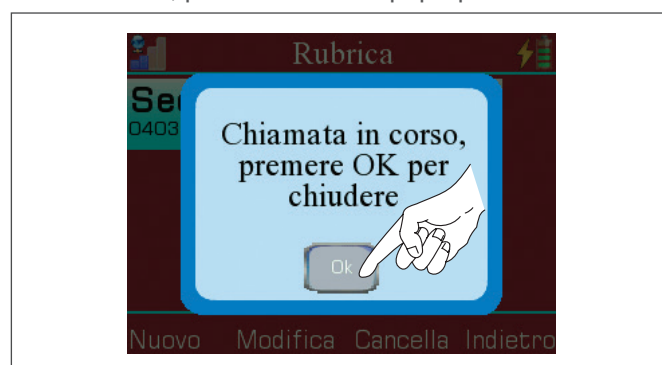

6.3.7 SMS

In the **main SMS screen** you can:

- Create a new message (using the “New” key).
- Edit a message (selecting one and then tapping “Edit” or double tapping the selected message).
- Delete a message (selecting one and then tapping “Delete”).
- Return to the main menu (tapping “Back”).



Create or edit an SMS:

- Enter the Title (name) of the message using the touch keypad.
- Enter the text of the message using the touch keypad.



6.3.8 Voice messages

In the **main Voice messages screen** you can:

- Create a new voice message (using the “New” key).
- Edit a voice message (selecting one and then tapping “Edit” or double tapping the selected voice message).
- Delete a voice message (selecting a voice message and then tapping “Delete”).
- Return to the main menu (tapping “Back”).

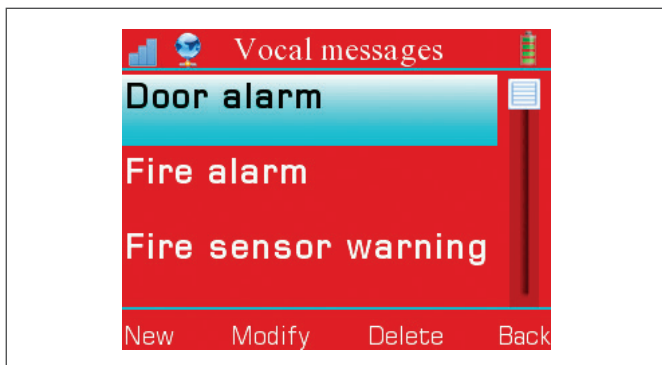

Create or edit a voice message:

- Enter the Title (name) of the voice message using the touch keypad.



- In the record screen, press REC (●) to record a voice message (maximum length is 20 seconds).
- Press STOP (■) to stop recording.
- Press PLAY (▶) to listen back to the recording.
- Repeat the procedure if you wish to change the recorded message.
- Press back (✕) and then save the recorded message by pressing “Ok”.



6.3.9 Configuration (Inputs, Outputs, Associations and Timer)

The following functions can be accessed from the **Configuration** menu:

- Inputs (←)
- Outputs (→)
- Associations (↔)
- Timer (🕒).

It is also possible to go back to the main menu by pressing “Back” in the bottom right of the screen.

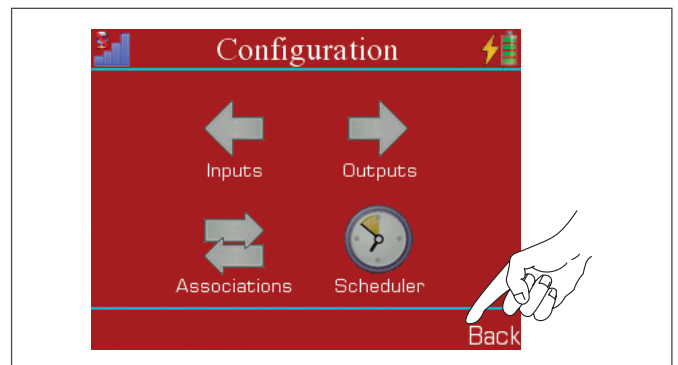

6.3.9.1 Inputs

To **configure an input**:

- Select an input from the inputs list, then tap “Edit”.
- Enter the name of the input using the touch keypad.

- Select the type of input on the screen (described below).
- Confirm by tapping "Save" in the bottom left of the screen.

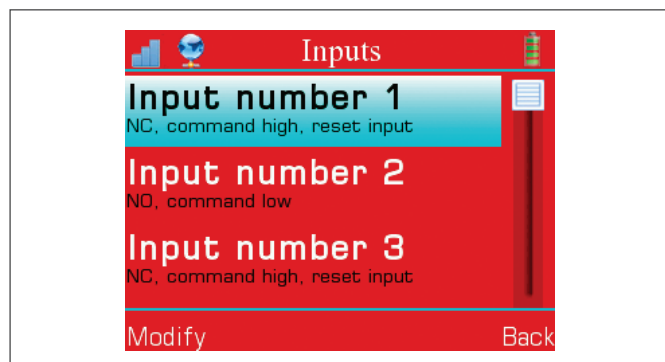

The **input type selection screen** contains 4 types of input:

- Normally open, low control (↘)
- Normally open, high control (↗)
- Normally closed, low control (↙)
- Normally closed, high control (↖)

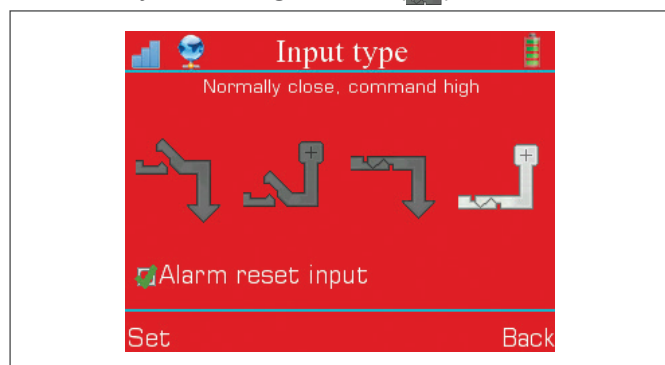

It is also possible to set:

- The input as **alarm block** (reset) by ticking the appropriate box. By doing so, the activation of the input will cause the alarm block (reset).
- The **Input activation delay** from 0.2 seconds to 1 hour, dragging the cursor on the selection bar at the bottom of the screen.

6.3.9.2 Outputs

To **configure an output**:

- Select an output from the outputs list, then tap "Edit".
- Enter the name of the output using the touch keypad.
- Select the type of output on the screen (described below).
- Confirm by tapping "Save" in the bottom left of the screen.

To **test an output**:

- Select the output and tap "Switch".

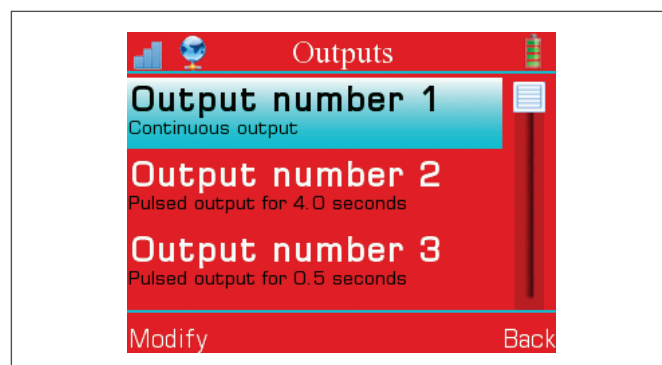

The **output type selection screen** contains 2 types of output:

- Continuous output (⌋)
- Pulsed output (⌋↘).

On selecting a pulsed output, you can also set the pulse time using the horizontal bar.

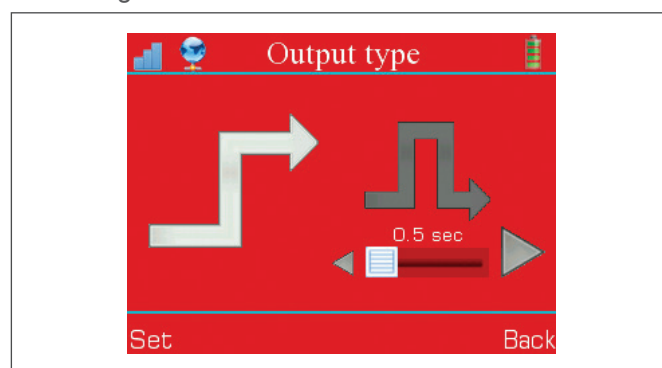

6.3.9.3 Associations

The **Associations menu** includes the list of triggers. These are formed by the names of the 6 inputs plus triggers for "No DC line", "Battery flat" and "Incoming call". The items on the list also show a description of the input type, providing a quick overview of the trigger in which actions are to be created or modified.

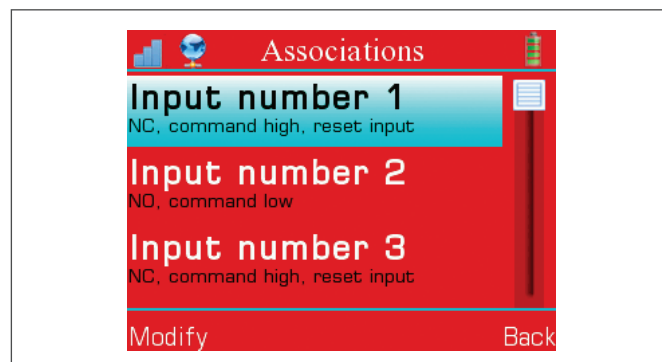

Selecting an item on the list and tapping "Edit" accesses the **"Actions List"** associated with that trigger. Here you can:

- Create new actions (tapping "New").
- Edit an action (selecting one and then tapping "Edit" or double tapping the selected action).
- Delete an action (selecting an action and then tapping "Delete").
- Return to the associations menu (tapping "Back").

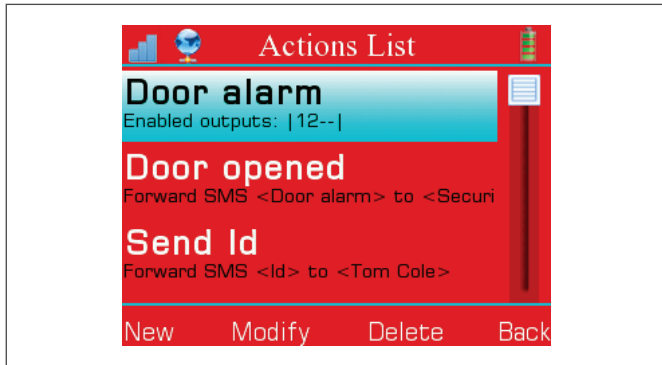

To create a send SMS action:

- Enter the name of the action using the touch keypad.
- Tap the messages icon at the top left.
- Select the "SMS" section in the centre of the screen and then tap "Add" (or double tap the selection) to add a message.
- Select the "Recipients:" section and then tap "Add" (or double tap the selection) to add a recipient.
- Repeat the operations to concatenate SMS messages or add other recipients.
- Tap "Save" to save the action.

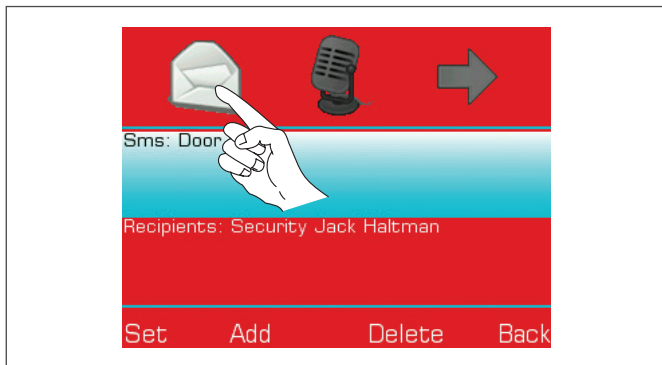

To create a send voice message action:

- Enter the name of the action using the touch keypad.
- Tap the voice messages icon at the top.
- Select the "Voice message:" section in the centre of the screen and then tap "Add" (or double tap the selection) to add a recording.
- Select the "Recipients:" section and then tap "Add" (or double tap the selection) to add a recipient.
- Repeat the operations to concatenate voice messages or add other recipients.
- Tap "Save" to save the action.

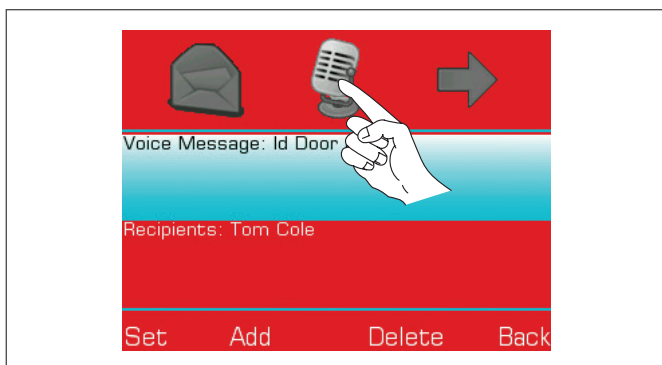

To create an output activation action:

- Enter the name of the action using the touch keypad.
- Tap the outputs icon at the top right.

- Tick the boxes relating to the outputs you want to activate with the selected trigger.
- Tap "Save" to save the action.

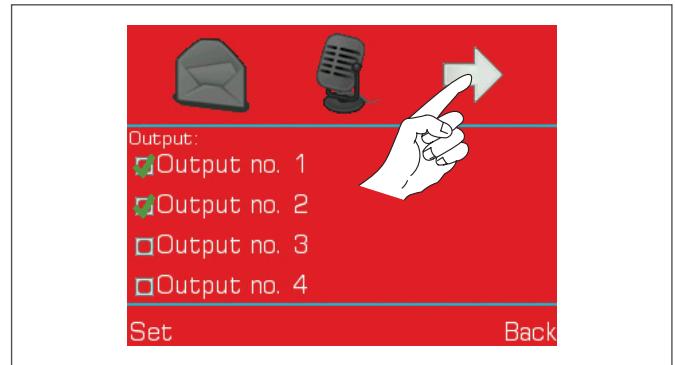

The **alarm sequence** of each trigger follows the order in which actions are entered. If more than one call actions occurs, the **GSM-00** will attempt to call all associated contacts. In case of a failed or unanswered call, after finishing the other calls it will make 5 more attempts as per the default setting (editable in "Set the alarm call sequence" a pag. 35 Justrite®) to call back the numbers that did not answer.

If a "reset" command is received from an enabled user, the **GSM-00** will attempt to complete the current action before interrupting the procedure. Therefore, please note that if the current action includes multiple calls to multiple contacts, the dialler will still make all scheduled calls even if the reset SMS is received.

During an alarm call, the dialler will display the telephone icon in the bottom left of the screen.

For example, if you wish to receive an SMS message when the door is opened (presuming it is connected to input 1):

- Add your number to the dialler's phone book.
- Create an SMS message.
- Select input 1 in the "Associations" screen.
- Create a new SMS action, entering the created message and your contact as the recipient.

The new event activation logic in case of line failure works as follows:

If there is at least one association on the line failure event, the dialler ignores the input events when a power failure occurs (which could otherwise trigger the alarm sequence unintentionally in the event of a power failure or instable input supply).

6.3.9.4 Timer

In the **timer menu** you can set programs and public holidays in the time programmer.

You can choose whether to set a program by accessing "Program list", or plan a holiday period in "Holiday list".

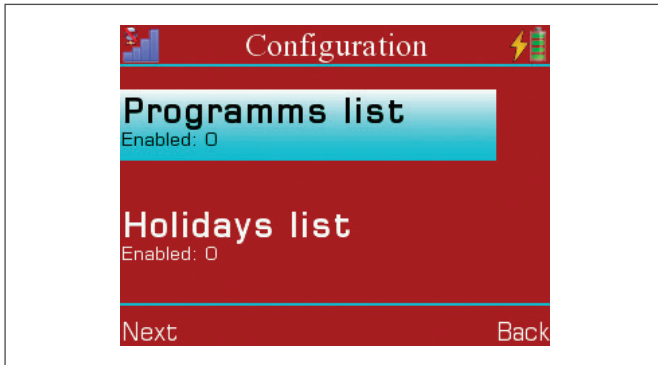

To set a program:

- Select "Program list", then select a program.
- Enter the name of the program.
- Enable the program by ticking the relevant box, then tick the inputs and outputs used by the program and the days of the week on which the program is to run.

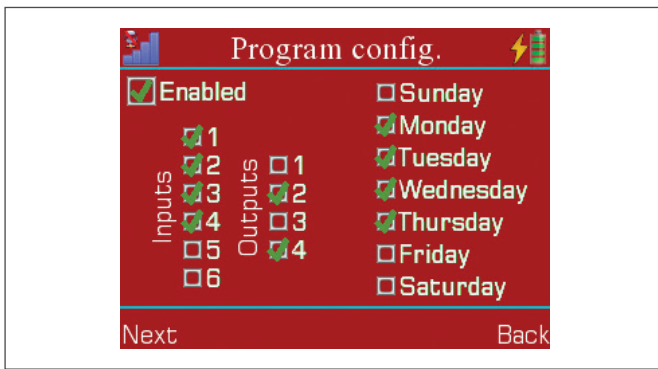

- On the next screen, you can set the time and the inputs and outputs to be enabled/disabled by ticking the relevant boxes.

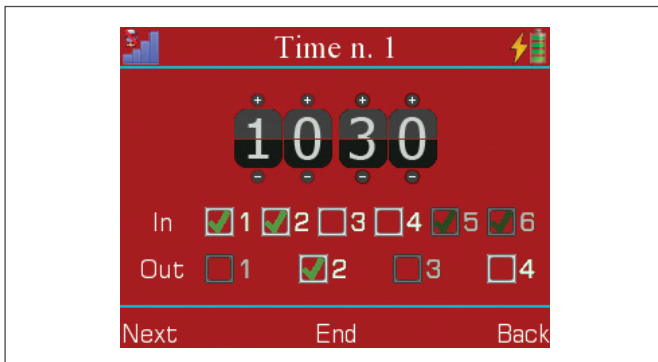

- Tap "Next" to add up to 4 events or "End" to save the changes made so far.

To set a public holiday:

- Select "Holiday list", then select a holiday.
- Enter the name of the holiday.
- Enable the holiday by ticking the relevant box, then select "Annual" if the holiday recurs every year.

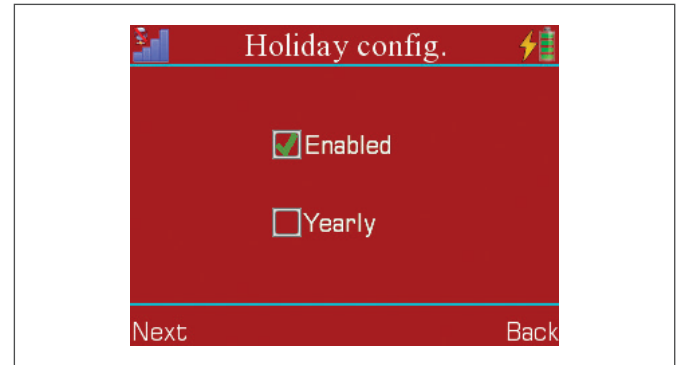

- Set the date and time the holiday starts, then tap next to set the end date and time.

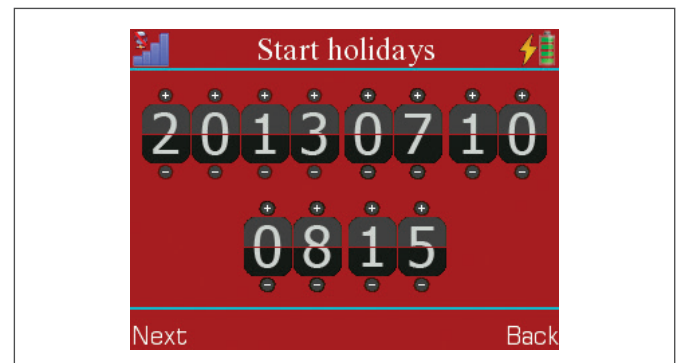

- Tap "End" to save and exit the configuration.

During a holiday, all active programs and programs set to run in that period are ignored, so the input and output settings remain as set for the last program.

6.3.10 Reports

The **reports screen** summarises all associations set for each trigger, providing a simple, complete overview of all actions set by the user.

It is made up of a list of triggers and the number of actions associated with each one.

To view details of a trigger select the desired item and tap "View" (or double tap the selected item).



The **trigger details screen** shows a list of associations set out as follows:

- Action name in square brackets.
- List of SMS or voice messages as appropriate.
- List of recipients.
- Enabled outputs, if the association is an "Output", displaying the number of outputs enabled and a dash

("-") for disabled outputs.



6.3.11 Settings

The **settings screen** includes:

- Change language.
- Calibrate touch screen.
- Change date and time.
- Edit GSM settings.
- Edit APN.
- Change user password.
- Change administrator password.
- Reset the **GSM-00**.
- View firmware version.
- Force restart.
- Remote technical support.
- Set up credit messages and SIM expiry alerts.
- Set the alarm call sequence.
- Enable auto-compiling function.
- Enable and set alarm controller.



CHANGE LANGUAGE

To change the language, select "Language" on the settings list and then tap "Edit".

In the selection screen, select the desired language and then tap "Change".

CALIBRATE TOUCH SCREEN

To calibrate the touch screen, select "Display" on the settings list and then tap "Edit".

In the new screen, tap "Ok" and then follow the on-screen instructions.

CHANGE DATE AND TIME

To change the date and time, select "Date / Time" on the settings list and then tap "Edit".

In the new screen, set the date (at the top) and the time (at the bottom) using the plus and minus symbols ("+", "-"), then tap "Save".

EDIT GSM SETTINGS

To edit the GSM settings, select "GSM" on the settings list and then tap "Edit".

The possible actions on this screen are:

- Increase and decrease the active status messages ("Alive") that the **GSM-00** sends to the administrator (users with "forward sms" active), informing him/her of correct device operation.
- Enable output 4 in the event of no GSM line. This output will remain active until the GSM signal is restored.



If this function is activated, do NOT use output 4 in the associations, as the behaviour of the device would not be determinable.

- Enable blind calls to allow voice recordings of set associations to be sent without waiting for the recipient to accept the call. (Useful for areas poorly served by GSM networks).
- Change GSM volume (of calls made by the **GSM-00**) by sliding the cursor on the horizontal bar.

Tap "Save" to save the settings.

EDIT APN



This procedure must be completed in order for the GPRS to work, which is necessary for remote programming and for upgrading the **GSM-00** firmware.

To **edit the APN**, select "APN" on the settings list and then tap "Edit".

Enter the APN of your provider on the touch keypad, then confirm.

CHANGE USER PASSWORD

To change the user password (set to "54321" by default), select "User Password" on the settings list and then tap "Edit".

Enter the current user password on the touch keypad, confirm and enter the new password. Confirm again to complete the operation.

CHANGE ADMINISTRATOR PASSWORD

To change the administrator password (set to "12345" by default), select "Administrator Password" on the settings list and then tap "Edit".

Enter the current administrator password on the touch keypad, confirm and enter the new password. Confirm again to complete the operation.

RESET THE GSM-00



Resetting the device restores factory settings, deleting any data added by the user.

To reset the **GSM-00**, select "Reset" on the settings list and then tap "Edit".

Enter the current administrator password on the touch keypad, then confirm to reset the dialler. After resetting, the touch screen calibration procedure starts, follow the on-screen instructions to finish the calibration (see "touch screen calibration").

VIEW FIRMWARE VERSION

Tap “Firmware version” to view the currently installed firmware version.

FORCE RESTART

To force a **GSM-00** restart, select “Force restart” on the settings list and then tap “Edit”.

Enter the current administrator password on the touch keypad, then confirm to restart the dialler.

REMOTE TECHNICAL SUPPORT

Remote technical support allows you to be contacted by telephone if problems are encountered in one of the components that enable the GSM dialler to function properly. Disabled by default, you can activate it by accessing “Remote support” in the “Settings” menu. Fill in the “Reference phone number” with a number enabled to receive calls and tick the enable service box.

SET UP CREDIT MESSAGES AND SIM EXPIRY ALERTS



To set up remaining credit functions and SIM expiry alerts, select “SIM” and tap edit, then:

- Select the text field below “Number or USSD for credit:” and type in the USSD (e.g. “*123” for WindTre) or your provider’s number for receiving remaining credit SMS (e.g. “404” for Vodafone, “40916” for TIM, “4155” for WindTre).
- If an SMS credit number is entered instead of the USSD, the “Use sms for credit. Text:” function must be ticked, then set the text of the message to be sent by selecting the text field below (e.g. “Traffic” for Vodafone, “Balance” for WindTre, “CREDIT” for Tim).
- If you wish to receive a SIM expiry alert, tick “SIM expiry alert SMS”. A date 11 months after the current date is automatically generated. The **GSM-00** will send the desired alert on that date. To refresh the date, remove and re-enter the tick, or select the date field.

SET THE ALARM CALL SEQUENCE

To set the alarm sequence, select “Alarm sequence” on the settings list and then tap “Edit”.

Increase or decrease the number of call attempts, then set the time interval between one attempt and the next (in seconds).



If “Standby on input 1” is ticked, input 1 works as a total dialler block, so it will not react to any alarm while this input is in alarm state. In these conditions, “Standby” appears on the main display to signal the dialler is not active. In the status SMS (“status” command), the text “StBy enabled” was added to the “System:” row if the function was enabled from the menu. The system status (standby or otherwise) is therefore visible on the “Inputs” row.

By ticking “Switch on backlight”, the screen will automatically switch on when an alarm sequence is triggered.

ENABLE AUTO-COMPILING FUNCTION

To edit the auto-compiling function, select “Auto-compile” on the settings list and then tap “Edit”. Tick the boxes of the data to be auto-compiled (Contacts, SMS, Voice messages, Associations), then tap “Save”.

While creating one of the items for which auto-compiling is active, a number name will automatically be entered in the text field on the name entry screen.

The automatic text is formatted as follows: “Contact.x” for contacts; “Sms.x” for SMS; “VoiceM.x” for voice messages; “Action.x” for associations, in which the item’s position number on the list appears in place of the “x”.

ENABLE AND SET ALARM CONTROLLER



The alarm controller function allow the telephone dialler to be used as an alarm panel. In the settings screen, once the function has been enabled, it is possible to select the inputs that will be controlled by the controller (“Total” row, those not selected will be “24h” inputs), those that will be activated in the event of partialization (“Partial” row), those that will be activated with a delay (“Delay” row), the length of the input and output delays. On the same screen it is also possible to set the activation/deactivation **password (default: 1122)** and select, by ticking “Output”, the use of output 1 as the system

status output (active output in case of total and partial activation, otherwise off). If the function is active, the main lock screen displays the system status (Off, Total on, Partial on) and six rectangular icons representing the status of each input with a combination of border and shading colours:

- White border: input active
- Blue border: input 24 h
- Grey border: input off
- Green shading: input in standby
- Red shading: Input in alarm state
- Grey shading: input disabled.

On the main screen, while the system is off, an input can be disabled or enabled by simply tapping its rectangular icon. The disabled/enabled status remains until an on/off cycle is completed.

Touching the padlock and entering the activation/deactivation password on the touch keypad will switch the system off (if it was on) or open the entry selection screen, where total or partial switch-on can be selected.

6.3.12 Status screen



The **status screen** shows:

- The activation status of the inputs ("1" signals input active, "-" signals input inactive). An active input would trigger an alarm at the output in maintenance mode.
- The activation status of the outputs ("1" signals output active, "-" signals output inactive).
- The battery voltage value.
- The power supply voltage value.

6.3.13 Events log



The **events log** records all the events listed below, up to a maximum of 960:

- Low battery.

- Power failure.
- No GSM network.
- Input "x" active (where "x" is the input number).
- Output "y" active (where "y" is the output number).
- Administrator login (tracks logins made using the administrator password).
- Administrator exit (tracks the number of times the **GSM-00** returns to locked state, when last accessed with the administrator password).
- User login (tracks logins made using the user password).
- User exit (tracks the number of times the **GSM-00** returns to locked state, when last accessed with the user password).
- Connected: "aaa.bbb.ccc.ddd" (where "aaa.bbb.ccc.ddd" is the IP of the PC to which the **GSM-00** is connected).
- "Contact" attempt: "x" (tracks the number of times that, during an alarm, the **GSM-00** attempts to call a contact without receiving an answer. "Contact" is the contact number; "x" is the number of attempts).
- Alarm resets (tracks all alarm resets).

All the above items appear in a list with a row underneath each one indicating the date and time the logged event occurred.

The log can be cleared by tapping "Clear log" at the bottom left of the screen.



From **firmware version 1.4.1** onwards, the "Events Log" also takes into account and stores the following items:

- "System On" when the system is switched on from the keypad.
- "On: tel num" when the system is switched on via SMS, showing the telephone number in place of "tel num".
- "System Off" when the system is switched off from the keypad.
- "Off: tel num" when the system is switched off via SMS, showing the telephone number in place of "tel num".
- "System Partialized" when the system is partialized from the keypad.
- "Partial: tel num" when the system is partialized via SMS, showing the telephone number in place of "tel num".
- "Disabled: num inputs" when one or more inputs are disabled from the keypad.
- "Disabled: num inputs, tel num" when one or more inputs are disabled via SMS, showing the telephone number in place of "tel num".
- "Enabled: num inputs" when one or more inputs are enabled from the keypad.
- "Enabled: num inputs, tel num" when one or more inputs are enabled via SMS, showing the telephone number in place of "tel num".

6.3.14 Remote commands

The remote commands enable the user to control the dialler remotely by sending an SMS to the device or using

DTMF commands during calls in an alarm phase.

In order for the sender's command to be recognised by the dialler, the sender's number must first be entered in the phone book.

Each SMS arriving from a phone number not entered in the phone book is forwarded to all contacts with the "Forward SMS" function set up. The commands can be written in upper or lowercase letters or in a combination of both.

REMOTE CONTROLLER MANAGEMENT

Use the following SMS commands to manage the alarm controller remotely:

- "Switch on": switches the system on.
- "Partialize": partializes the system.
- "Switch off": switches the system off.

These commands can be used by all users with the "Alarm Block" function enabled.

Example SMS: SWITCH ON

Example SMS: PARTIALIZE

Example SMS: SWITCH OFF

"DISABLE" AND "ENABLE" COMMANDS

The "DISABLE" and "ENABLE" commands can be used by users with the "Alarm Block" function enabled. The former allows the system to completely ignore the triggering of disabled inputs, while the latter re-enables the normal triggering (enabling) of previously ignored inputs. Both commands can be concatenated, so several inputs can be disabled or enabled with a single SMS.

Example of "DISABLE" SMS (disable input 3): DISABLE 3

Example of "ENABLE" SMS (enable inputs 4 and 6): ENABLE 4 6

6.3.14.1 SMS Commands

"CONFIG" COMMAND

The "CONFIG" command is for accessing the TCP/IP port of a PC to receive data from the **GSM-00** Programmer software, and can only be used by users with the "Alarm Block" option set, or by all phone numbers if the phone book contains no contacts.

To use this command, send "CONFIG remote_ip remote_port password random_number" as an SMS message, where:

- "remote_ip" is the public IP to which the **GSM-00** must connect (ddd.ddd.ddd.ddd).
- "remote_port" is the port at which the machine is listening (5000-65535) and which the **GSM-00** must access.
- "password" is the administrator password.
- "random_number" is the random four-digit number generated by the **GSM-00** Programmer software.

Example of SMS (for a remote_ip = 235.123.100.75, remote_port = 7888, password = 12345 random_number = 4277): CONFIG 235.123.100.75 7888 12345 4277

"RESET" COMMAND

The alarm "RESET" command can only be used by contacts with the "Alarm Block" function set.

To use this command, send "RESET" as an SMS message.

Example SMS: RESET

The **GSM-00** will block all currently active alarms.

"ACTIVATE" COMMAND

The "ACTIVATE" command is for activating a **GSM-00** output, and can be used by those whose phone book contacts are authorised to activate the specified output.

To use this command, send "ACTIVATE output" as an SMS message, where "output" is the specific output to be activated (1-4).

Example of SMS (for output = 2): ACTIVATE 2

The "ACTIVATE" command can be concatenated, so several outputs can be activated at a time by simply adding the number of the outputs to be activated, separated by a space:

Example of SMS (for output = 1 and 4): ACTIVATE 1 4

"HELP" COMMAND

The "HELP" command is used to request the list of remote commands from the **GSM-00**, which will reply with an SMS listing all commands that can be used by sending a command SMS. This command can be used by all phone book contacts.

To use this command, send "HELP" as an SMS message.

Example SMS: HELP

"DEACTIVATE" COMMAND

The "DEACTIVATE" command is used to deactivate a **GSM-00** output, and can only be used by users with the relative "Actuation output" enabled.

To use this command, send "DEACTIVATE output" as an SMS message, where "output" is the specific output to be deactivated (1-4).

Example of SMS (for output = 2): DEACTIVATE 2

The "DEACTIVATE" command can be concatenated, so several outputs can be deactivated at a time by simply adding the number of the outputs to be deactivated, separated by a space:

Example of SMS (for output = 1 and 4): DEACTIVATE 1 4

"STATUS" COMMAND

The "STATUS" command is used to request the status of the **GSM-00**, which will reply with a status SMS. It can be used by all phone book contacts.

To use this command, send "STATUS" as an SMS message.

Example SMS: STATUS

 In **firmware version 1.4.1**, the “System:” row has been added followed by:

- “not enabled” if the function is not active;
- “off”;
- “total on”;
- “partial on”.

“CREDIT” COMMAND

The “CREDIT” command can be used by anyone in the phone book.

To use this command, send “CREDIT” as an SMS message.

Example SMS: CREDIT

The **GSM-00** will reply with an SMS message containing the remaining credit.

“EVENT” COMMAND

The “EVENT” command is for activating a **GSM-00** event, and can be used by those whose phone book contacts are authorised to control at least one output.

To use this command, send “EVENT input” as an SMS message, where “input” is the specific input of the event to be activated (1-6).

Example of SMS (for input = 6): EVENT 6

 If an input is activated which also has the task of resetting the alarm, the latter will only be blocked if the user is authorised to block the alarm (contact option “Alarm Block”).

“INFO” COMMAND

The “INFO” command is used to ask **GSM-00** for the list of input names active at that moment. This command can be used by all users in the phone book.

To use this command, send “INFO” as an SMS message.

Example SMS: INFO

The **GSM-00** will reply with the list of names of the active inputs. If an input name is longer than 20 characters, it will be abbreviated to 17 characters plus 3 dots.

“INPUTS” COMMAND

The “INPUTS” command is used to obtain the list of input names and their status. This command can be used by all users in the phone book.

To use this command, send “INPUTS” as an SMS message.

Example SMS: INPUTS

The **GSM-00** will reply with the list of names of all inputs, showing “1” on the right if the input is active or “-” if it is inactive. If an input name is longer than 20 characters, it will be abbreviated to 17 characters plus 3 dots.

6.3.14.2 DTMF Commands

“DTMF” COMMANDS

DTMF commands can be used during a call from the **GSM-00** in alarm procedure. To use these commands, the user needs the same permissions required for the equivalent SMS commands.

The touch-tone keypad can be used to:

- Block active alarms with the hash key (#) (user with “Alarm block”). In this case the alarm sequence ends immediately.
- Activate an output with number keys **1, 2, 3, 4** (User authorised to activate the relative output).
- Deactivate an output with number keys **5, 6, 7, 8** for **outputs 1, 2, 3, 4** respectively: key 5 = output 1; key 6 = output 2; key 7 = output 3; key 8 = output 4 (User authorised to activate the relative output).

6.3.15 Remote programming via software

The latest version of the **GSM-00** Programmer software can be downloaded from www.synaps-technology.com.

It offers the possibility of creating the dialler configuration system in a very similar way to the device itself. You can do this from your PC, and send it to the **GSM-00** through an internet connection with a public IP. You can also download the latest firmware from our server to update the dialler with the new functions.



To establish a connection between the software and **GSM-00**:

- Make sure you have an internet connection with a public IP.
- Enter the administrator password in the “Configuration” menu (tap “Change password” to confirm the change).
- In the top toolbar, open “Dialler” then “Send configurations”.

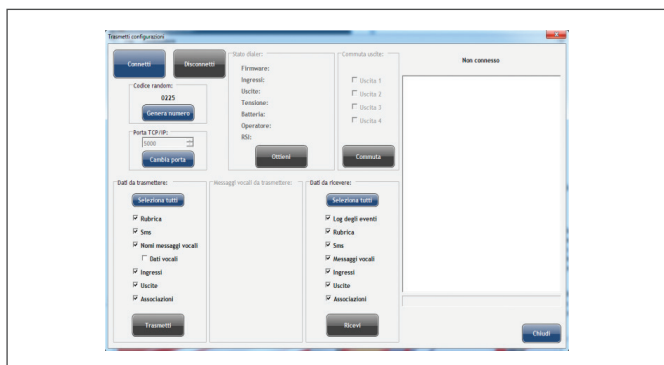

- Tap "Change port", enter a port between 5000 and 65535, tap "Change port" again to confirm.
- Tap Connect.
- Make sure you are registered on the dialler as a user authorised to use the Config remote commands ("Alarm block" option in contact settings).
- Send a Config SMS to the **GSM-00**. The wording is "**CONFIG remote_ip remote_port password_admin random_number**".

Example of SMS if remote_ip = 235.123.100.75, remote_port = 7800, password_admin = 12345, random_number = 4277: **CONFIG 235.123.100.75 7800 12345 4277**

- Wait for the program to connect.
- Once connected, you can program or update the dialler firmware.

To program a GSM-00 using the software:

- Select the data to be sent or received by ticking the relevant boxes and tapping "Send" or "Receive" (audio messages recorded on the dialler cannot be received due to the reduced upload capacity of GPRS connections, but they can be sent).
- In this screen, you can switch the outputs and obtain information on the device.
- After completing the operations, tap "Disconnect".

To update the firmware of a GSM-00 dialler from the software:

- Make sure you have an internet connection with a public IP.
- Enter the administrator password in the "Configuration" menu (tap "Change password" to confirm the change).
- Select the "Firmware" tab at the top.

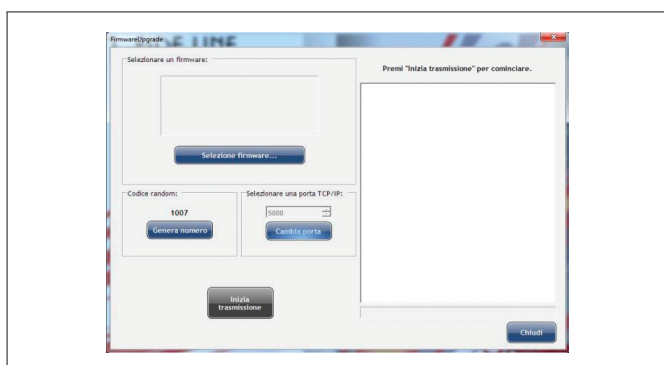

- Tap "Select firmware..." and select the firmware to be downloaded (alternatively, you can put a firmware in the "Firmware" folder of the software and it will appear in the list).
- Tap "Send transmission".
- After completing the operations, tap "Disconnect" in the previous tab.

6.3.16 Quick guide to Android app

The latest version of the DS 100 app can be downloaded from www.synaps-technology.com.

It allows you to organise one or more diallers via a simple screen, send SMS commands to them without writing them manually, and keep track of the diallers' status with the "Keep-Alive" function.

The following actions are possible on the main screen:

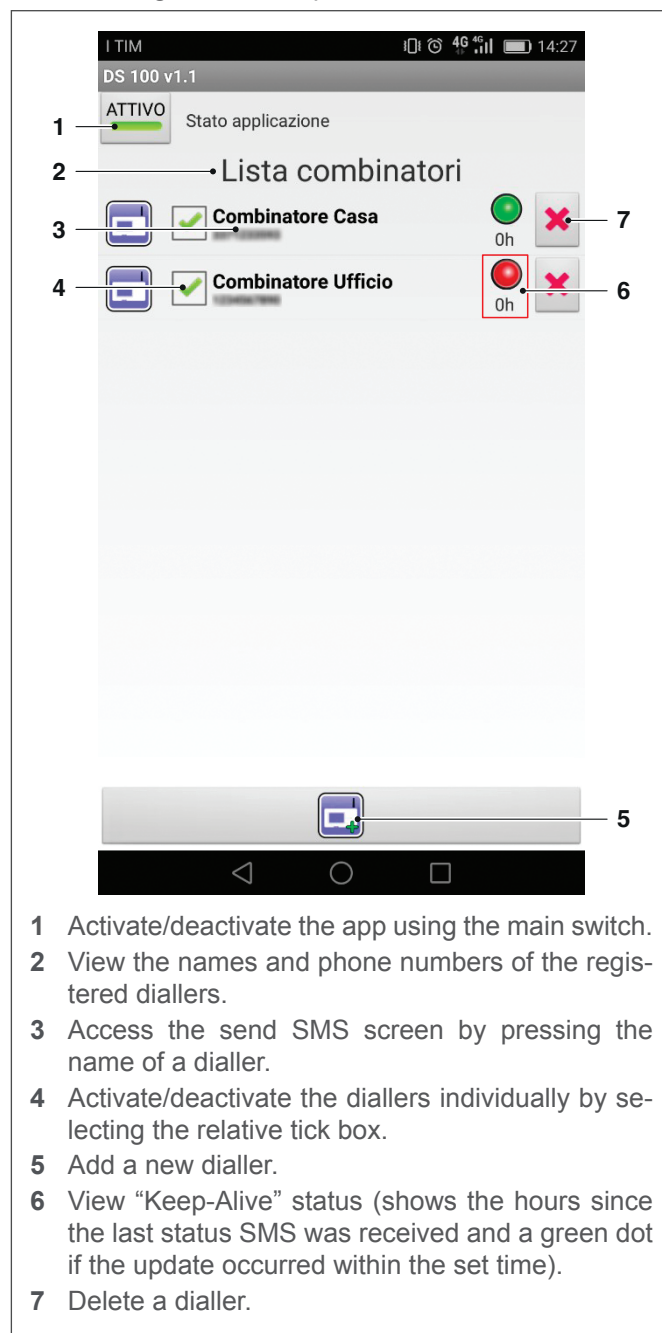

- 1 Activate/deactivate the app using the main switch.
- 2 View the names and phone numbers of the registered diallers.
- 3 Access the send SMS screen by pressing the name of a dialler.
- 4 Activate/deactivate the diallers individually by selecting the relative tick box.
- 5 Add a new dialler.
- 6 View "Keep-Alive" status (shows the hours since the last status SMS was received and a green dot if the update occurred within the set time).
- 7 Delete a dialler.

The send SMS screen allows you to send pre-compiled commands to the dialler.

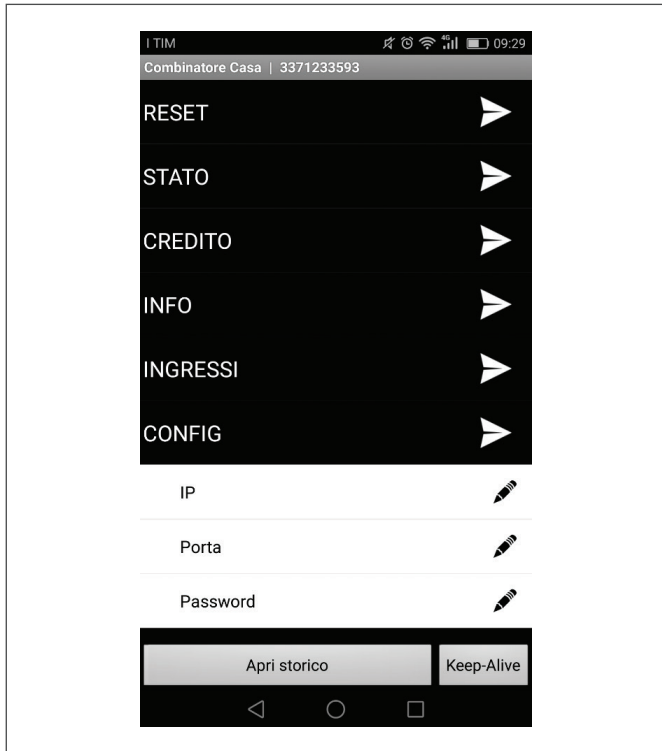

The “Keep-Alive” button at the bottom right of the screen allows you to set up a monitoring system based on “STATUS” messages. The dropdown menu is for selecting the operating mode.

- **Active:** the app will only keep track of the last status SMS received. This function assumes the dialler is set up with keep-alive active.
- **Forced:** the app will send the status command with a frequency set on the numeric selector at the bottom.

The SMS screen has an “Open history” button at the bottom left. Tap it to view the messages received by the dialler.



While receiving a call from a registered dialler, you can send the “RESET” command using the button in the notification generated by the app, which will appear in your smartphone’s notification centre.

6.4 Automatic extinguishant controller (FPC)

The controller is part of the automatic extinguishing system consisting of:

- automatic extinguisher, for 60 - 90 - 120 FPC cabinets;
- with control panel;
- smoke temperature sensor;
- flashing light.

6.4.1 Overview

The **FPC** automatic suppression controller monitors the detection and automatic suppression of a fire in a cabinet using a linear thermal detection cable or automatic smoke detectors and **Justrite®** aerosol generators.

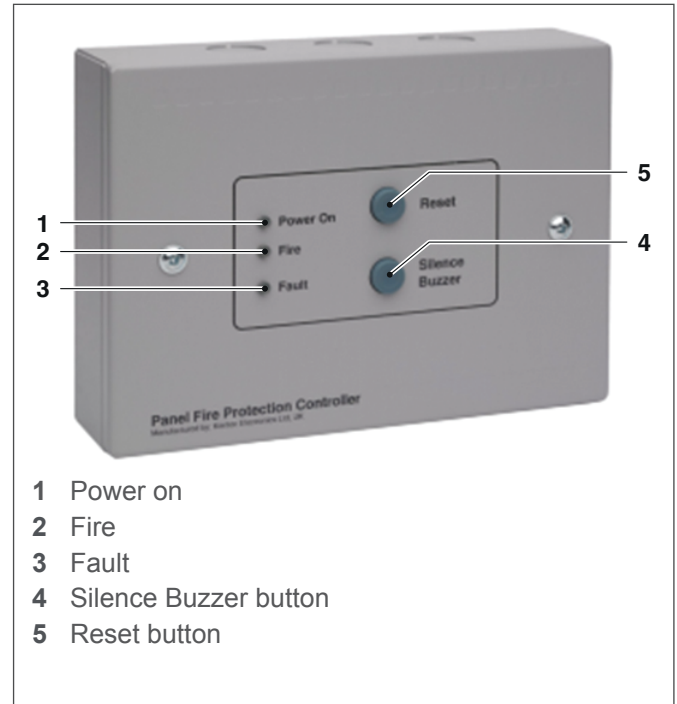

The **FPC** features a detection input for connecting a heat detection linear cable, smoke detectors or a combination of both, which is monitored for disconnection of the detection devices.

There are four outputs for connecting **Justrite®** aerosol generators and disconnecting any of these triggers a fault.

To operate the aerosol generators, the **FPC** requires a 24 V DC battery capable of providing 3 A for a short period. Terminals are provided for the inlet and outlet connection of the 24 V DC power supply.

Volt-free contacts are available to signal fire and fault conditions in the system or other monitoring equipment. By selecting the appropriate jumper layout, an addressable input module can be connected via a simple 2-wire connection.

6.4.2 Operation

In normal conditions, only the green power light (1) is on, none of the outputs is active and the buzzer is silent.

All wiring is monitored and any disconnection switches on the yellow fault light (3) on the front panel and activates the buzzer.

The internal volt-free fault contact will operate and sig-

nal any external equipment connected to the controller. There are internal indicators to signal whether the fault concerns the wiring of the detection circuit or the wiring of the aerosol generators.

The buzzer can be silenced by pressing Silence Buzzer (4).

When a heat detection linear cable or a smoke detector activates, the red fire light (2) switches on, the **Justrite®** aerosol generators activate and immediately discharge extinguishing powder into the protected area, the buzzer sounds and the fault light (3) switches on, indicating that the aerosol generators have been activated and must be replaced.

The internal volt-free fire contact will operate and signal any external equipment connected to the controller.

The buzzer can be silenced by pressing Silence Buzzer (4).

Following the activation of a fire and the replacement of the **Justrite®** aerosol generators, normal operating conditions can be restored by pressing Reset (5) on the front of the controller.

Note: the controller will continue to show a fault condition until the aerosol generators are replaced.

6.4.3 Technical data

SPECIFICATIONS	
Total dimensions	188 x 132 x 47 (mm)
Structure	1/2 mm sheet steel
Finish	Epoxy powder coating
Colour	BS OO A 05 textured light grey
Operating voltage	19 to 30 Volt DC
Current draw in standby	18 mA
Maximum current draw	1.6 Amps
Mains power fuse	1.6 Amp (Quick Blow)
Terminals	max 2.52 mm

6.4.4 Installation

6.4.4.1 Fastening

The front panel of the **FPC** must be removed by loosening the two M4 fastening screws holding it in place and stored in a safe place together with the screws for subsequent reassembly.

The back of the controller can then be used to mark the fastening position holes in the required point.

The back of the controller must be mounted with minimum 4 mm diameter screws in all four fastening positions.

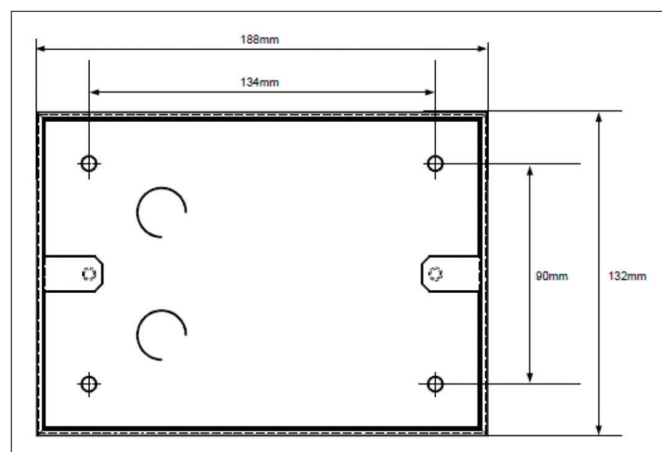

The back of the controller has a series of 20 mm holes at the top, rear and bottom.

Remove the necessary pre-cut parts and fit the 20 mm cable glands for routing the necessary cables.

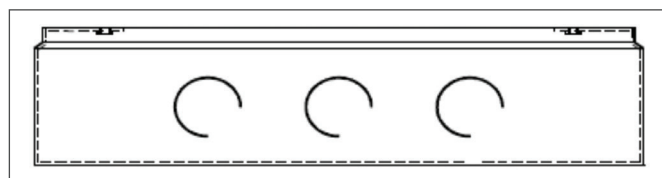

Once all cables are in place, connections can be made to the circuit board mounted on the front of the controller.

All connections must be made while the power supply is off.

6.4.4.2 Connections to the circuit board

All external wiring connections are on a single row of terminals on the top of the control board.

The resistance of any cable must not exceed 25 ohm.

The terminals can accept wires up to 2.5 mm².

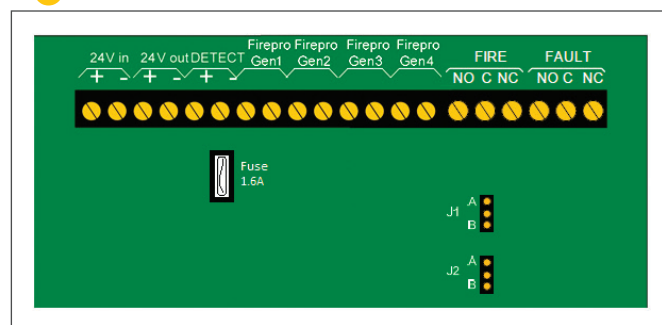

6.4.4.3 24V IN / 24V OUT Power Supply

The polarity of these terminals is very important.

The 24V IN connector is for connecting the power supply of a previous unit or power supply unit, while the 24V OUT is for connecting other units.

Use a cable with at least 1.5 mm² cross-section and a maximum length of 100 metres or a cable with at least 2.5 mm² cross-section and a maximum length of 160 metres.

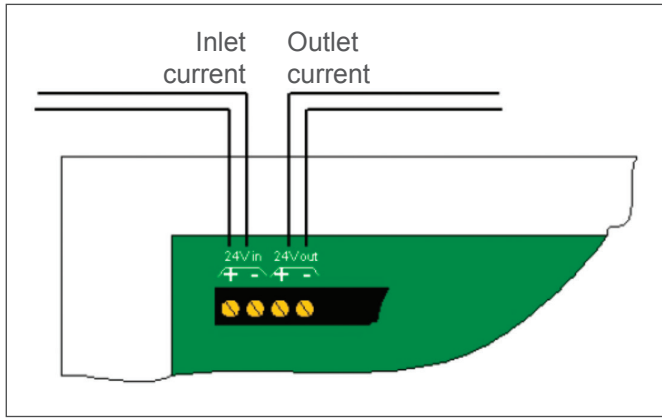

6.4.4.4 Detection

These terminals are for connecting a standard 24 V smoke detector or another detection device such as a heat detection linear cable.

A 6K8 end-of-line monitoring resistor is mounted on these terminals, which must be removed and placed at the end of the detection circuit wiring to provide open-circuit monitoring for the detection cable.

Automatic smoke detectors are sensitive to polarity, so it must be respected. If a short-circuit occurs on the detection line (due to activation of the linear heat detector or smoke detector [470 Ohm] or due to an error), the panel will immediately activate the fire protection procedure.

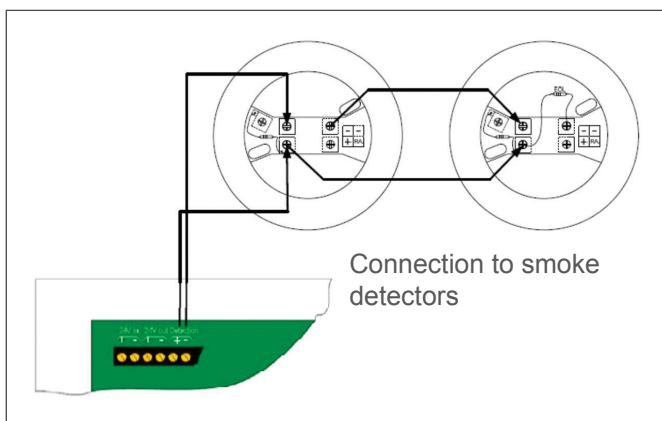
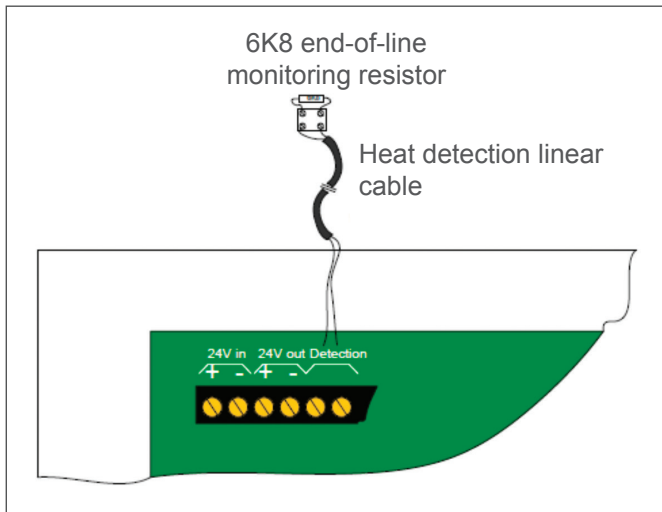

6.4.4.5 Connecting powder extinguishers to activation circuit (GEN1 - GEN4)

These terminals are for connecting powder extinguishers. The terminals have indicator lights to allow the system to be tested before connecting the powder extinguishers. These test lights must be removed from the terminals when installing the powder extinguishers.

Generator outlets that are not used must be left with the test lights fitted.

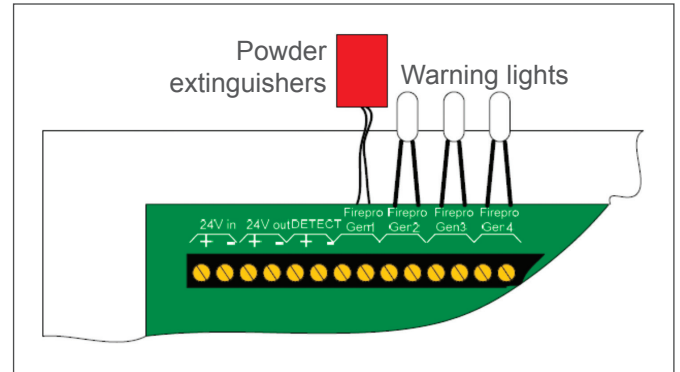

6.4.4.6 Remote signalling contact (FIRE)

Volt-free switching contact which comes into operation whenever the system is activated due to an alarm and remains active until the control panel is reset.

This contact is classified for max 30 V DC and 1Amp. These values must not be exceeded.

6.4.4.7 Fault relay (FAULT)

Volt-free switching contact which activates whenever a fault occurs either on the detection part or the extinguishing part of the control panel.

This contact is classified for max 30 V DC and 1Amp. These values must not be exceeded.

6.4.5 Testing and commissioning

DISCONNECT ALL POWDER EXTINGUISHERS BEFORE RUNNING THE TEST.

Once all powder extinguishers are disconnected from the panel, make sure the test lights provided with the unit are mounted on terminals GEN1 to GEN4.

Do not leave the powder extinguishers connected to the unit during the test; otherwise they will activate.

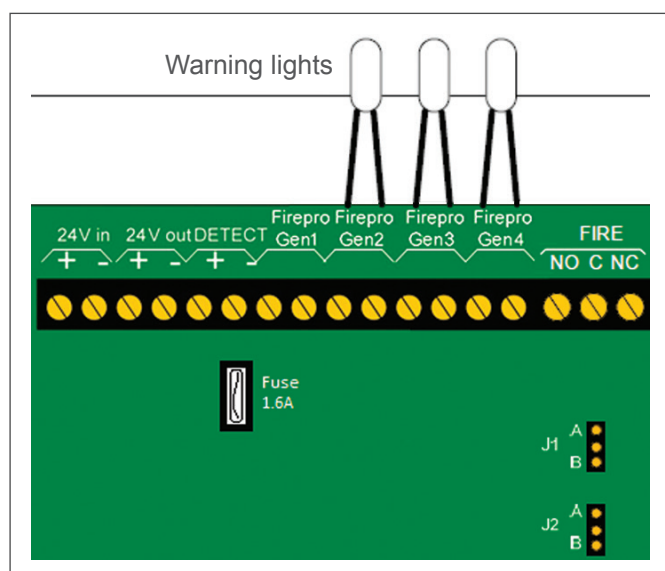

Proceed as follows to run the test.

- Make sure both jumpers (J1 and J2) are in position "A".
- Activate the detection input by triggering a smoke detector or linear heat detector.
- Check that:
 - the test lights connected to terminals GEN1 to GEN4 switch on immediately;
 - the red fire light on the front panel switches on;
 - the yellow fault light switches on;
 - the buzzer sounds.
- Press "Silence Buzzer" to silence the buzzer and then press "Reset" to reset the system.
- Disconnect the wiring of the detector and make sure that the yellow fault LED on the front panel and the yellow internal LED marked LED4 are on and the buzzer is active. Press "Silence Buzzer" and make sure the buzzer switches off. Reconnect the wiring of the detector and make sure that the yellow fault light switches off.
- Disconnect one of the test lights and make sure that the yellow fault LED on the front panel and the yellow internal LED marked LED5 are on and the buzzer is active. Press "Silence Buzzer" and make sure the buzzer switches off. Reconnect the test light and check that the fault light switches off.

6.4.6 System diagram

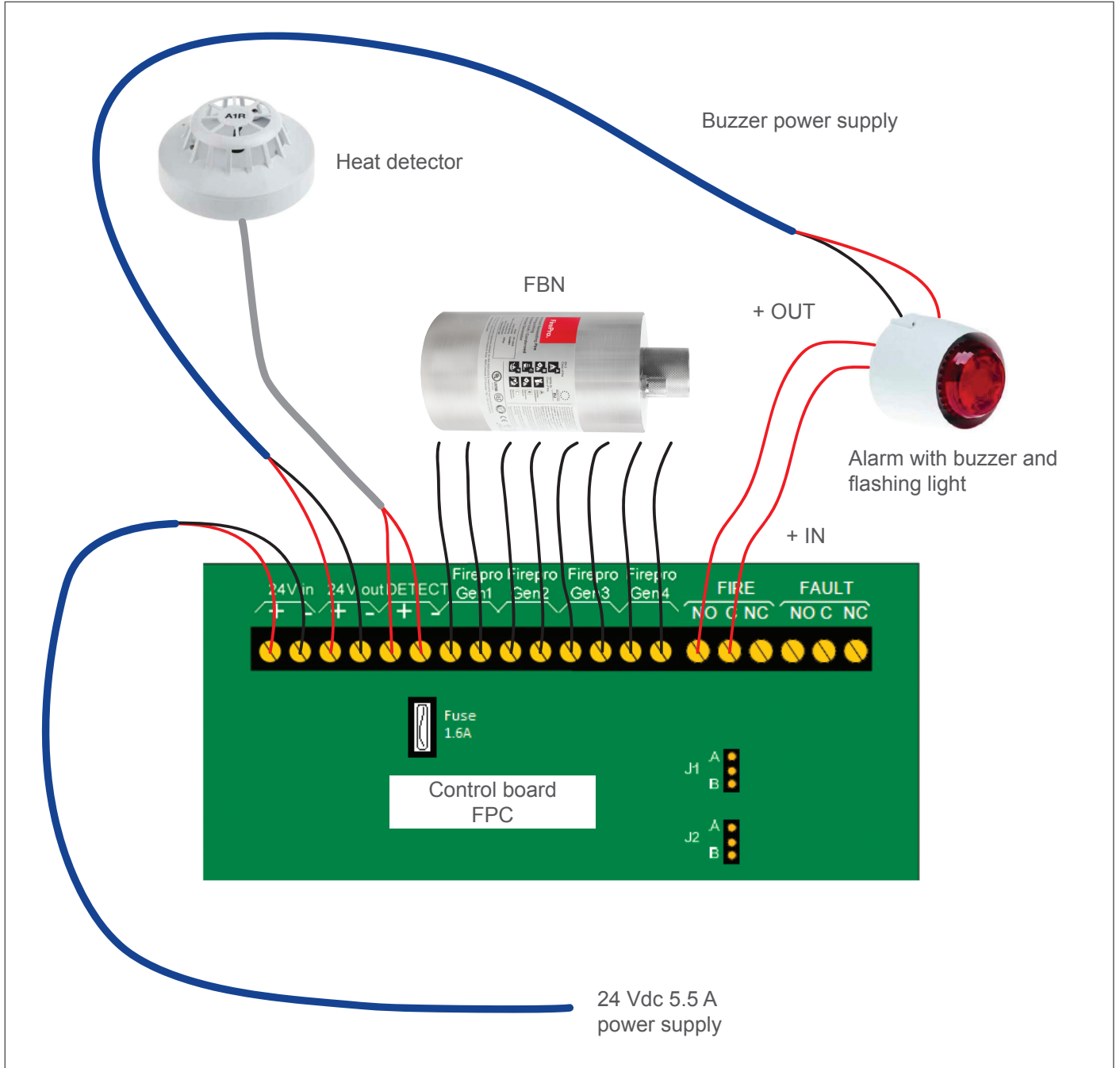

7 MAINTENANCE

The cabinet is Collective Protective Equipment (CPE) and must be checked at least once a year (by the authorised technical support service).

If corrosive liquids are stored, check the safety devices every six months (by the authorised technical support service).

Use only original spare parts.

With regular maintenance/servicing, the Safety Cabinet is expected to last approximately 10 years.

Some components may need replacing sooner.



Each cabinet must have an **Inspections and maintenance register** as set out in the next section.



AVOID modifying or tampering with individual parts even if they are of minor importance. Product maintenance must be carried out by personnel from the authorised technical support service.



Before approaching electrical equipment of any type, make sure that the main power supply has been CUT OFF.

7.1 Inspections and maintenance register

The **Inspections and Maintenance Register** must be drawn up for each Safety Cabinet and must contain:

- product data;
- data from maintenance and efficiency inspections conducted, in chronological order;
- the signature of the authorised technician who carried out the operations.

The inspection and maintenance reports issued must be attached to the **Inspections and Maintenance Register**.



Further inspections and operations may be necessary whenever specified by the product manufacturer and/or installer, in accordance with the instructions contained in the manual issued by the manufacturer.

7.2 Routine maintenance

Routine maintenance on collective protective equipment is essential to safeguard the health of laboratory operators and users.

It involves regular maintenance and inspections of the product.

7.2.1 Daily and monthly checks to be carried out autonomously

DAILY FUNCTIONAL CHECK

- check the collection trays (absorb and remove any spills).

MONTHLY FUNCTIONAL CHECK

- efficient operation of the doors:
 - hinges
 - locking systems
 - door closer (if present)
 - door locking system
- correct seating and status of the fire-protection seals
- vents
- earthing connection

Oil and grease all movable parts, using solely oils free of resins and acids.



In case of damage, contact the authorised technical support service to have the cabinet repaired with original parts. The cabinets can be cleaned using a mild household detergent and a soft cloth.

7.3 Extraordinary maintenance

Extraordinary maintenance includes all operations such as improvement maintenance and major preventive maintenance (such as servicing, which generally increases the value of systems and/or extends their working life).



Once all the operations have been completed, the authorised technical support service must issue a validation protocol for each cabinet containing:

- all the results measured on site;
- all original certificates relating to the instruments used;
- an original copy conforming to the instrument calibration certificates.

8 DECOMMISSIONING

8.1 After normal use

Affix the “out of order” sign, or similar sign, to the cabinet. Leave a safety area around the cabinet measuring roughly 2 metres and 0.5 metre above the floor.



Before beginning work, we recommend laying absorbent paper and/or towels on the floor before proceeding with any operation (see www.chemisafe.it for further information).

The doors can now be opened. Remove all the products stored inside. Empty the tray shelves and the collection tray at the bottom of the cabinet and clean them thoroughly. Aerate the cabinet for at least one working day. With sufficient ventilation, the cabinet’s working life can be extended.

8.2 After a fire

Inform the fire brigade on the contents of the cabinet and the circumstances that triggered the fire.

Before opening the cabinet, remove all ignition sources within 10 metres of the cabinet.

Only use non-sparking tools, avoid any cutting tools and flame working tools.

Open the cabinets with the utmost caution and ONLY after a period of time corresponding to SIX TIMES the duration of the fire, but if the surface of the cabinet is still hot to the touch, wait longer.

Keep adequate suppression devices within reach while opening the cabinet.



Before beginning work, we recommend laying absorbent paper and/or towels on the floor before proceeding with any operation (see www.chemisafe.it for further information).

9 DEACTIVATION AND DISPOSAL



If the product is to be disposed of together with the lock or door locking system, MAKE SURE THAT these devices have been made unusable to prevent children from getting trapped inside.

9.1 Deactivation

If the cabinet is to be transferred to another storage site or once it reaches the end of its technical and service life, it must be deactivated.

It is therefore necessary to:

- switch the appliance off;
- disconnect the power sources;
- dismantle and separate the various units making up the appliance;

When handling the parts of the cabinet and storing them temporarily, protect the parts most at risk, such as:

Door	Use rigid packaging (wooden cage, rigid cardboard), taking extra care with the edges.
Shelves and painted parts	Wrap in light paper and then cover the surface with plastic (light polyethylene) to protect against moisture. Pack the parts with light cardboard to protect them against impacts.
Electrical panels and accessories	Wrap in plastic (light polyethylene) to protect against moisture and cover with light cardboard to protect against impacts.

9.1.1 Precautions for storage

Place the cabinet or its components in adequately protected environments, with maximum 70% relative humidity and temperature between 0°C and + 35°C.

After retrieving the cabinet from the warehouse, the following operations should be carried out before proceeding with the new installation:

- check the condition of the electrical equipment;
- contact the authorised technical support service to check the cabinet, request the updated inspection and maintenance reports and attach them to the **Inspections and Maintenance Register**.



Never leave the cabinet exposed to the elements.



In case of doubts regarding transport and storage, contact the authorised technical support service.

9.2 Disposal

If the cabinet is to be scrapped, separate its constituent parts accordingly for disposal.

Sort the materials by type and contact specialised waste disposal companies, in accordance with the provisions of the law.



Justrite® accepts no liability for harm to persons, pets or property arising from the reuse of single cabinet parts for functions or assembly situations other than the original ones.



The cabinet is made of non-biodegradable materials. Contact authorised and specialised waste disposal companies to dispose of the parts or of the entire cabinet. Refer to the local laws on waste disposal.

9.3 Information for users

The product is subject to the treatment envisaged in Art. 13, "Implementation of Directives 2002/95/EC, 2002/96/EC and 2003/108/EC on the restriction of the use of certain hazardous substances in electrical and electronic equipment, and waste disposal".

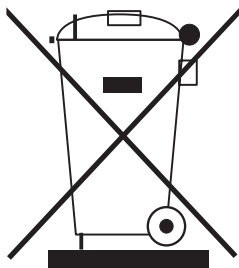

The crossed-out wheeled bin symbol on the equipment or its packaging indicates that the product must be collected separately from other waste at the end of its useful life. The separate collection of this equipment at the end of its life is organised and managed by the manufacturer. The user wishing to dispose of this equipment must

contact the manufacturer and follow the system adopted by the latter for the separate collection of equipment that has reached the end of its life. The adequate separate collection of the decommissioned equipment for subsequent recycling, treatment and environmentally compatible disposal helps to prevent possible negative effects on the environment and human health and favours the reuse and/or recycling of the equipment's constituent materials.



The unlawful disposal of the product by the possessor implies the application of the administrative penalties envisaged in the regulations in force.

10 TROUBLESHOOTING



Justrite® accepts no liability for harm to persons, pets or property arising from failure to comply with the safety regulations and recommendations in the documentation provided.



If faults occur, contact the authorised technical support service.



Please contact customer service if you have any additional questions. We will be happy to assist you!
SalesEU@justrite.com

Justrite Safety Group is a growing family of companies dedicated to industrial safety. With ten different brands in its portfolio, each with a specific focus, Justrite Safety Group provides the essential safety products you need to protect your workers and your workplace.

